

thenew

ZOWIN

classic collection

2023



the new
ZOWN
classic collection

Maxchief

investments LTD.

Is a holding company of Taiwanese origin with industrial plants in Mainland China, engaged primarily in the manufacture of office, garden and contract furniture. It set up "Dongguan Shichang Metals Factory Ltd." in August 1994 (65,000 m²) and the factory "Zhuhai Shichang Metals Ltd." in May 2010 (190,000 m²), where the holding company's main offices are currently found.

MAXCHIEF EUROPE S.L. was established in August 2008 as the holding company's sales and marketing subsidiary in Barcelona, one of the world's benchmark cities for industrial design, innovation and creativity.

Es un holding de origen taiwanés con plantas industriales en China Continental, principalmente dedicadas a la fabricación de mobiliario de oficina, jardín y hostelería. En Agosto de 1994 creó la fábrica "Dongguan Shichang Metals Factory Ltd" (65.000 m²) y en mayo de 2010 la fábrica "Zhuhai Shichang Metals Ltd" (190.000 m²), dónde en la actualidad se encuentran las oficinas principales del holding.

MAXCHIEF EUROPE S.L. se constituyó en Agosto de 2008 como filial comercial y de marketing del Holding en Barcelona, una de las ciudades de referencia en el mundo en lo que respecta al diseño industrial, la innovación y la creatividad.

Est une holding d'origine taiwanaise avec des usines industrielles en Chine continentale, se consacrant essentiellement à la fabrication de mobilier de bureau, de jardin et d'hôtellerie. En août 1994, la holding a fondé l'entreprise "Dongguan Shichang Metals Factory Ltd" (65.000 m²). En mai 2010 est créée l'entreprise "Zhuhai Shichang Metals Ltd" (190 000 m²), où se trouvent actuellement ses bureaux principaux.

MAXCHIEF EUROPE S.L. a été constituée en août 2008 comme filiale commerciale et marketing de la holding à Barcelone, une des villes de référence dans le monde en ce qui concerne le design industriel, l'innovation et la créativité.

Ist eine Holding aus Taiwan mit Fertigungswerken in Festlandchina, in denen hauptsächlich Büro-, Garten- sowie Hotel- und Gastronomiemöbel hergestellt werden. Im August 1994 wurde das Werk „Dongguan Shichang Metals Factory Ltd“ (65.000 m²) und im Mai 2010 das Werk "Zhuhai Shichang Metals Ltd" (190.000m²) eröffnet, wo sich derzeit auch der Hauptsitz der Holding befindet.

MAXCHIEF EUROPE S.L. wurde im August 2008 als Vertriebs- und Marketingtochter der Holding mit Sitz in Barcelona gegründet, einer der weltweit führenden Städte in den Bereichen Industriedesign, Innovation und Kreativität.

China

Zhuhai Shichang Metals Ltd.
Zhuhai, Guangdong, China

Dongguan Shichang Metals Factory Ltd.
Dongguan, Guangdong, China

Engineering and Product Development.
Facilities equipped with cutting-edge technology.
Operations Management techniques seeking the highest quality and efficiency.

Ingeniería y Desarrollo de producto.
Instalaciones con tecnología de última generación.
Técnicas de Dirección de Operaciones orientada a la eficiencia y a la calidad total.

Ingénierie et Développement de produit.
Installations dotées d'une technologie de dernière génération.
Techniques de Direction des Opérations visant l'efficacité et la qualité totale.

Produktentwicklung und Engineering.
Anlagen mit modernster Technologie.
Betriebsmanagement-Techniken zur Gewährleistung von Effizienz und umfassender Qualität.

Barcelona

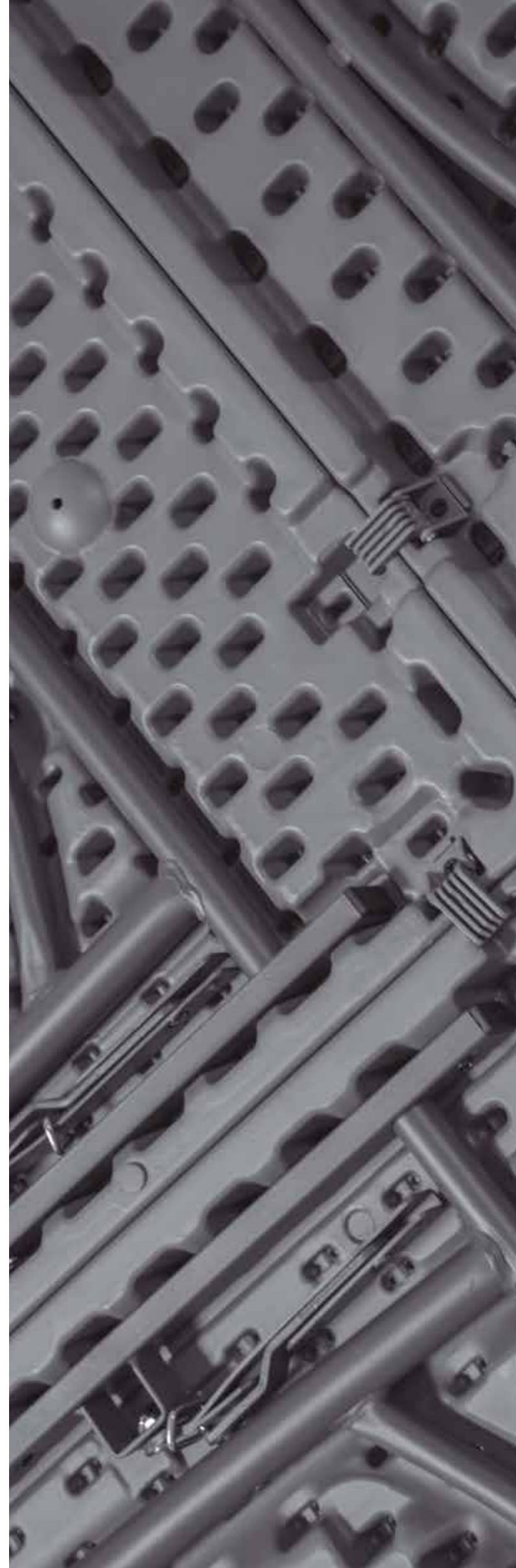
Maxchief Europe S.L.
Barcelona, Spain

Market needs assessment.
Innovation, Creativity and Design.
European warranty.
Flexible and effective logistics.
Customer service.

Investigación de las necesidades del mercado.
Innovación, Creatividad y Diseño.
Garantía europea.
Logística flexible y eficaz.
Servicio al cliente.

Evaluation des besoins du marché.
Innovation, Créativité et Design.
Garantie européenne.
Logistique flexible et efficace.
Service au client.

Erforschung der Marktbedürfnisse.
Innovation, Kreativität und Design.
Gewährleistung europäischer Standards.
Flexible und effiziente Logistik.
Dienst am Kunden.



Factory Fábrica Usine Werk

Each and every member of the company team strives to constantly improve the level of quality and efficiency. In recognition of this commitment, the company was awarded the certifications for a quality management system (ISO 9001: 2015), environmental management system (ISO 14001: 2015), occupational health and safety management system (ISO 45001: 2018) and energy management systems (ISO 50001: 2018).

The factory is equipped with 41 HDPE blow moulding machines, 12 polypropylene injection machines and several steel pipe production lines. The factory is also fitted out with 45 digital welding robots and 4 powder coating lines. All of the above yields a production of between 600 and 800 containers per month.

Todo el equipo de la empresa trabaja orientado hacia la mejora continua de la calidad y la eficiencia. En reconocimiento a este compromiso, la compañía ha recibido certificaciones de gestión de la calidad (ISO 9001: 2015), del impacto medioambiental (ISO 14001: 2015), así como de la gestión de la salud y la seguridad en el trabajo (ISO 45001: 2018) y sistemas de gestión de la energía (ISO 50001: 2018).

Las plantas productivas cuentan con 41 máquinas de tecnología HDPE blow moulding, 12 inyectoras de Polipropileno y varias líneas de fabricación de tubo de acero. Disponen también de 45 robots de soldadura digital y 4 cadenas de pintado poder coating. Todo ello permite alcanzar producciones de 600 a 800 containers al mes.

Toute l'équipe de l'entreprise travaille dans l'optique de l'amélioration continue de la qualité et de l'efficacité. En reconnaissance à cet engagement, la compagnie a reçu les certifications de gestion de la qualité (ISO 9001: 2015), de l'impact environnemental (ISO 14001: 2015), ainsi que celle de la gestion de la santé et de la sécurité au travail (ISO 45001: 2018) et systèmes de management de l'énergie (ISO 50001: 2018).

Les ateliers de production disposent de 41 machines de technologie HDPE blow moulding, de 12 machines à injection de polypropylène et de plusieurs chaînes de fabrication de tubes en acier. Ils disposent également de 45 robots de soudage numérique et de 4 chaînes de peinture poder coating. Tout cela permet d'atteindre un rythme de production de 600 à 800 containers par mois.

Der gesamte Mitarbeiterstab des Unternehmens ist auf die ständige Verbesserung der Qualität und Effizienz ausgerichtet. In Anerkennung dieses Engagements hat das Unternehmen Zertifizierungen in den Bereichen Qualitätsmanagement (ISO 9001: 2015), Umweltmanagement (ISO 14001: 2015) sowie Sicherheit und Gesundheit am Arbeitsplatz (ISO 45001: 2018) erhalten und energiemanagementsysteme (ISO 50001:2018).

Die Fertigungswerke verfügen über 41 HDPE-Blasformanlagen, 12 Polypropylen-Spritzgussanlagen und mehrere Produktionsstraßen für Stahlrohre. Dazu kommen 45 digitale Schweißroboter und 4 Pulverlackieranlagen. Dank dieser Einrichtungen können monatlich zwischen 600 und 800 Container mit unseren Produkten beladen werden.





ZOWN CONTRACT DESIGN FACTORY constitutes the holding company's brand targeting the **contract furniture** market, underpinned by a business philosophy which **integrates the entire value chain** (supply of raw materials, design, development, manufacture, distribution) and **combines the best of Asia and Europe** within one organisation.

From Asia, China brings **advanced engineering, excellent organisational and production capacity**, as well as **modern and fascinating infrastructure**. From Europe, the team lends its expertise in **assessing the needs** of the global market, in **creativity** and in **design**. It manages **distribution** and provides a European **warranty** as well as effective and **flexible logistics**, basing its philosophy on the constant pursuit of innovation and commitment to customer **service**. Since January 2015 Maxchief Europe S.L. has **internalised its logistics**, becoming established in a new industrial warehouse of 4,800 m² in Llinars del Vallès, Barcelona.

ZOWN CONTRACT DESIGN FACTORY est la marque du holding; ciblée sur le marché du **meuble à usage professionnel**, elle repose sur une philosophie d'entreprise qui **intègre toute la chaîne de valeur** (approvisionnement en matières premières, conception, développement, fabrication, distribution) et qui **associe le meilleur de l'Asie et de l'Europe** au sein de la même organisation. De l'Asie, la Chine apporte une **ingénierie de pointe**, une **excellente capacité d'organisation et de production**, ainsi que des **infrastructures modernes et fascinantes**.

D'Europe, l'équipe offre son expertise en matière d'**évaluation des besoins** du marché mondial, de créativité et de design. Elle gère la **distribution** et assure une **garantie** européenne, ainsi qu'une logistique flexible et efficace, sa philosophie étant fondée sur la recherche constante de l'**innovation** et sur son engagement envers le **service** à la clientèle.

Depuis janvier 2015, Maxchief Europe S.L. **internalise la fonction logistique** en établissant un nouveau bâtiment industriel de 4800 m² à Llinars del Vallès, province de Barcelone.

ZOWN CONTRACT DESIGN FACTORY es la marca del holding orientada al mercado del mobiliario de uso profesional, respaldada por una filosofía empresarial que integra toda la cadena de valor (aprovisionamiento de materias primas, diseño, desarrollo, fabricación, distribución) y combina lo mejor de Asia y Europa dentro de la misma organización. Desde Asia, China aporta una ingeniería avanzada, una capacidad organizativa y productiva excelentes, así como unas infraestructuras modernas y fascinantes.

El equipo de Europa contribuye con la investigación de las necesidades del mercado global, la creatividad y el diseño. Gestiona la distribución, ofrece garantía europea así como una logística flexible y eficaz, basando siempre su trabajo en los pilares de la innovación y la obsesión por el servicio al cliente.

Desde Enero de 2015 Maxchief Europe S.L. internaliza la función logística estableciéndose en una nueva nave industrial de 4800 m² en Llinars del Vallès, Barcelona.

ZOWN CONTRACT DESIGN FACTORY ist die Marke der Holding für **Gewerbemöbel**, deren Unternehmensphilosophie die gesamte Wertschöpfungskette (Beschaffung der Rohstoffe, Design, Entwicklung, Herstellung, Vertrieb) integriert und die Vorzüge Asiens und Europas in einer Organisation verbindet.

China steuert eine hochentwickelte Technik sowie hervorragende Organisations- und Produktionskapazitäten und moderne, faszinierende Infrastrukturen in Asien bei.

Das europäische Team trägt Kreativität und Design sowie seine Erfahrung in der Einschätzung der globalen Marktbedürfnisse bei. Darüber hinaus kümmert es sich um den Vertrieb und gewährleistet die Einhaltung europäischer Standards sowie eine effiziente und flexible Logistik auf der Grundlage einer Philosophie der ständigen Innovation und der Verpflichtung für den Dienst am Kunden.

Seit Januar 2015 hat Maxchief Europe S.L. die Logistikfunktion übernommen und zu diesem Zweck eine neue, 4.800 m² große Industriehalle in Llinars del Vallès (Provinz Barcelona) bezogen.

Why? ¿Por qué? Pourquoi? Warum?

Because the professional needs furniture:
Porque el profesional necesita mobiliario:
Parce que les professionnels ont besoin de mobilier:
Weil Profis hohe Anforderungen an Möbel stellen:



Light and shock-proof.
Ligero y resistente a los impactos.
Léger et résistant en cas de choc.
Sie sollen leicht und schlagfest sein.



Assembled and disassembled rapidly, safely and repeatedly.
Rápido y seguro para ser montado y desmontado con frecuencia.
Rapide et sûr pour être monté et démonté fréquemment.
Schnell und sicher auf- und abzubauen.



Stable and capable of withstanding weight.
Estable y adecuado para soportar peso.
Stable et apte à supporter des charges lourdes.
Stabil und von hoher Tragkraft.



Easily transported and stored, saving space.
Fácil de transportar y de ser almacenado economizando espacio.
Facile à transporter et à stocker en économisant de l'espace.
Leicht zu transportieren und platzsparend aufzubewahren.



Durable, competitive and low-maintenance.
Duradero, competitivo y de bajo mantenimiento.
Durable, compétitif et nécessitant peu d'entretien.
Langlebig, preisgünstig und pflegeleicht.



Manufactured from easy-to-clean hygienic materials.
Fabricado con materiales higiénicos y fáciles de limpiar.
Fabriqué à base de matériaux hygiéniques et faciles à nettoyer.
Aus hygienischen Werkstoffen gefertigt und leicht zu reinigen.



Comfortable for users. With a broad range of compatible models of various sizes.
Cómodo para los usuarios. Con amplia variedad de modelos compatibles, de diferentes dimensiones.
Pratique pour les utilisateurs. Possédant une grande variété de modèles compatibles, de différentes dimensions.
Bequem für die Benutzer. Verfügbar in einer breiten Produktpalette und in unterschiedlichen Größen.



UV and water-resistant protection. Ideal for prolonged outdoor use but should not be exposed permanently or in extreme conditions (particularly high humidity or salinity levels).
Protección UV e Hidrófuga. Ideal para uso exterior prolongado pero no permanente ni extremo (especialmente humedad o salinidad alta).
Protection UV et hydrofuge. Idéal pour une utilisation extérieure prolongée mais non permanente ni en conditions extrêmes (en particulier humidité ou haute salinité).
UV-geschützt und wasserabweisend. Ideal für längere Verwendung im Außenbereich oder extreme Einsatzbedingungen (insbesondere hoher Salzgehalt bzw. Feuchtigkeit) geeignet.

Made to last with
sustainability in mind.

**Fabricados para durar
pensando en la sostenibilidad.**

Conçu pour durer avec
la pérennisation à l'esprit.

**Hergestellt mit Blick auf
Langlebigkeit und
Nachhaltigkeit.**

At **ZOWN** we strive to manufacture durable furniture by using materials that ensure a long lifespan for each piece.

Since the **furniture's sustainability** also hinges on its durability, at Zown we can pride ourselves on manufacturing long-lasting tables and chairs, **thus reducing their environmental impact**. What's more, once the piece of furniture reaches the end of its service life, its materials can be reused or recycled to give life to other products. **We thereby also contribute to the circular economy.**

Chez **ZOWN**, nous nous efforçons de fabriquer des meubles durables en utilisant des matériaux qui garantissent une longue durée de vie à chaque pièce.

Puisque la **pérennisation du meuble** passe aussi par sa durabilité, chez Zown nous pouvons nous targuer de fabriquer des tables et des chaises durables, **réduisant ainsi leur impact environnemental**. De plus, une fois que le meuble arrive en fin de vie, ses matériaux peuvent être réutilisés ou recyclés pour donner vie à d'autres produits. **Nous contribuons ainsi également à l'économie circulaire.**

En ZOWN nos esforzamos por fabricar mobiliario duradero, utilizando materiales que aseguren una larga vida útil para cada pieza. Porque la sostenibilidad del mobiliario también depende de su durabilidad, en Zown podemos enorgullecernos de fabricar mesas y sillas de larga duración reduciendo así el impacto medioambiental.

Además, una vez que el mueble llega al final de su vida útil, sus materiales pueden ser reutilizados o reciclados para dar vida a otros productos. Con ello, contribuimos también a la economía circular.

Wir von ZOWN sind bestrebt, langlebige Möbel herzustellen, indem wir Materialien verwenden, die eine lange Lebensdauer der einzelnen Stücke gewährleisten.

Da die Nachhaltigkeit der Möbel auch von ihrer Langlebigkeit abhängt, sind wir von Zown stolz darauf, langlebige Tische und Stühle herzustellen und damit deren Umweltbelastung zu verringern. Und wenn das Möbelstück das Ende seiner Lebensdauer erreicht hat, können seine Materialien wiederverwendet oder recycelt werden, um anderen Produkten Leben einzuhauchen. Damit leisten wir auch einen Beitrag zur Kreislaufwirtschaft.



- Steel / **Acero** / Acier / **Stahl**
- Polymethylene Oxide / **Polióxido de Metileno** / Polyoxyde de Méthylène / **Plymethylenoxid**
- Polypropylene / **Polipropileno** / Polypropylène / **Polypropylen**
- High Density Polyethylene / **Polietileno de Alta Densidad** / Polyéthylène de Haute Densité / **Polyethylen mit hoher Dichte**

TABLE OF CONTENTS
 TABLA DE CONTENIDOS
 SOMMAIRE
 INHALTSVERZEICHNIS

Introduction

| | |
|-----------------------|----|
| thenew | |
| zownclassiccollection | 12 |
| thetextilecollection | 23 |
| key / leyenda | |
| / légende / legende | 30 |

45 cm / 18"]

M System

| | |
|------|----|
| M183 | 33 |
|------|----|

60 cm / 24"]

L System

| | |
|----------|----|
| L120 | 34 |
| Ltrolley | 35 |

76 cm / 30"]

XL System

| | |
|--------------|----|
| XL120 | 36 |
| XL150 | 40 |
| XL180 | 42 |
| XL180vintage | 44 |
| worktop180 | 46 |
| topshelf180 | 48 |
| XL240 | 50 |
| XLtrolley | 52 |
| XLmoon | 54 |
| XLcorner | 58 |

90 cm / 36"]

XXL System

| | |
|------------|----|
| XXL90 | 60 |
| XXL180 | 62 |
| XXL200 | 66 |
| XXL240 | 70 |
| XXLtrolley | 72 |
| XXLmoon | 74 |
| XXLcorner | 76 |



o ● **Planet System**

| | |
|---------------|----|
| planet120 | 78 |
| planet150 | 80 |
| planet160 | 84 |
| planet180 | 86 |
| planettrolley | 90 |



Other items

| | |
|----------------------------|-----|
| NEW multitrolley | 92 |
| cocktail80 | 94 |
| praxis80 | 100 |
| bistrot70 | 101 |
| cocktailtrolley | 104 |
| oktober175 | 105 |
| sharpbench180 | 106 |
| sharptable | 107 |
| munich50 | 108 |
| munich70 | 110 |
| munichbench | 111 |
| NEW dakotapicnicset | 112 |
| SS60 | 114 |
| SS120 | 115 |
| displayrack | 146 |



Chairs

| | |
|------------------------------------|-----|
| alvarstool | 96 |
| alexchairNC | 116 |
| NEW mega-connectoralexchair | 117 |
| bigalexchair | 118 |
| bigalexrolley | 119 |
| alexrolley | 122 |
| NEW olafchair | 124 |
| NEW olafskidchair | 125 |
| normanchair | 126 |
| normantrolley | 127 |
| NEW aranchairplus | 128 |
| NEW aranchairstandard | 129 |
| NEW arantrolley | 130 |
| NEW ludwigchair | 131 |
| NEW boston-kchair | 134 |
| liamtrolley | 135 |
| NEW malmöchair | 136 |
| NEW malmö-kchair | 137 |
| NEW güntherchair | 138 |
| NEW günther-kchair | 139 |
| NEW bryggen-kchair | 140 |
| NEW trumanchair | 141 |
| almachair | 142 |
| almaarmchair | 143 |



thenew
ZOWN
 classiccollection

Following fifteen years of proven success on the international market, ZOWN has renewed its entire CLASSIC collection. The modernised range of products has been renamed the NEW ZOWN CLASSIC COLLECTION.

The NEW ZOWN CLASSIC COLLECTION features aesthetic, technical and ergonomic improvements and is manufactured in a new shark grey colour that replaces the traditional light grey shade.

All the tables are equipped with a new and very smooth locking mechanism and the foot pads are inserted into the inner perimeter of the legs. The rectangular tables in particular have better ergonomics at the head, a lengthwise and crosswise joining system and an improved load capacity.

Después de 15 años de éxito contrastado en el mercado internacional, ZOWN renueva totalmente su colección CLASSIC. La modernizada gama de productos recibe el nombre de NEW ZOWN CLASSIC.

NEW ZOWN CLASSIC incorpora mejoras estéticas, técnicas y ergonómicas y se fabrica en un nuevo color gris oscuro azulado (shark grey) que sustituye al tradicional gris claro.

Todas las mesas cuentan con un nuevo sistema de bloqueo muy suave y los tacos de apoyo al suelo se insertan en el perímetro interior de las patas. Las mesas rectangulares, en particular, cuentan con mayor ergonomía en la cabecera, con un sistema de unión longitudinal y transversal de mesas y con una mejorada capacidad de carga.

Après 15 ans de succès confirmé sur le marché international, ZOWN renouvelle totalement sa collection CLASSIC. La gamme modernisée de produits reçoit le nom de NEW ZOWN CLASSIC. La collection NEW ZOWN CLASSIC incorpore des améliorations esthétiques, techniques et ergonomiques. Elle est fabriquée en adoptant une nouvelle couleur gris foncé bleuté (shark grey) qui remplace le traditionnel gris clair.

Toutes les tables disposent d'un nouveau système de blocage très doux et les embouts au sol sont insérés dans le périmètre intérieur des pieds. Les tables rectangulaires, en particulier, sont dotées d'une plus grande ergonomie à la tête, avec un système de raccord longitudinal et transversal de tables et avec une capacité de charge améliorée.

Nach 15 Jahren Erfolg auf dem internationalen Markt führt ZOWN eine umfassende Erneuerung seiner Kollektion CLASSIC durch. Die erneuerte Produktpalette erhält den Namen NEW ZOWN CLASSIC.

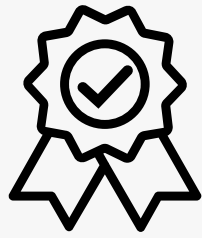
NEW ZOWN CLASSIC zeichnet sich durch Verbesserungen in Aussehen, Technik und Ergonomie aus und wird in einer neuen dunkelblaugrauen Farbe (shark grey) hergestellt, die das traditionelle hellgrau ersetzt.

Alle Tische sind mit einer neuen, sehr leichtgängigen Verriegelung ausgestattet und die Schutzkappen sind im Innendurchmesser der Tischbeine integriert. Die rechteckigen Tische zeichnen sich durch eine bessere Ergonomie am Tischende, ein Längs- und Querverbindungssystem und eine höhere Tragkraft aus.



Quality Calidad Qualité Qualität

**100%
PURE HDPE.
NOT MIXED**



Zown solely uses 100% pure (first generation) high-density polyethylene, which is not mixed with recycled plastic polymers.

Zown solo utiliza polietileno de alta densidad 100% puro (primera generación), no está mezclado con polímeros de plástico reciclados.

Zown utilise uniquement du polyéthylène haute densité 100% pure (première génération), qui n'est pas mélangé avec des polymères plastiques recyclés.

Zown verwendet ausschließlich 100% reines HDPE (erster Generation), das nicht mit recycelten Polymerkunststoffen vermischt wird.

Zown products comply with European product testing: 581-1/581-2/581-3/15372/16139/16121.

Los productos Zown cumplen con tests europeos de producto: 581-1/581-2/581-3/15372/16139/16121.

Les produits Zown ont passé les tests européens de produit: 581-1/581-2/581-3/15372/16139/16121.

Die Zown-Produkte entsprechen den Anforderungen der europäischen Produktprüfungen: 581-1/581-2/581-3/15372/16139/16121.

Longwise and widthwise table connectors.

Sistema de unión longitudinal y transversal.

Système de raccord longitudinal et transversal.

Verbindungssystem zur Längs- und Querverbindung.

Ergonomic. Comfortable for those seated at the end of the table.

Ergonomía. Pleno confort también, para los usuarios ubicados en las cabeceras de la mesa.

Ergonomie. Confort total aussi pour les personnes situées en bout de table.

Ergonomie. Uneingeschränkter Sitzkomfort auch an der Kopfseite des Tisches.



New and very smooth manual locking mechanism. Includes automatic sliding rings to prevent undesired folding should the locking mechanism not be engaged properly.

Nuevo bloqueador manual de manejo muy suave. Incluye argollas autodeslizantes de seguridad para evitar el plegado involuntario en caso de no fijar correctamente el bloqueador.

Nouveau mécanisme de blocage manuel au maniement très doux. Il inclut des anneaux autoglissant de sécurité pour éviter le pliage involontaire en cas de fixation incorrecte du mécanisme de blocage.

Neue, sehr leichtgängige, manuelle Verriegelung. Mit selbstgleitenden Sicherheitsringen, die ein unerwünschtes Zusammenklappen bei unsachgemäß befestigter Verriegelung verhindern.

The tester reloaded



We set out to compare the impact resistance of our new ZOWN XL180 table with that of a cheap table from an unbranded competitor. To perform the test, we hired the toughest guy we've ever met. Check out the result!

Nos propusimos comparar la resistencia a los impactos de nuestra nueva mesa ZOWN XL180 respecto a una mesa barata de un competidor sin marca. Para realizar la prueba contratamos al tipo más duro que hemos conocido nunca. ¡Comprueba el resultado!

Nous avons entrepris de comparer la résistance aux chocs de notre nouvelle table ZOWN XL180 à une table bon marché d'un concurrent sans marque. Pour effectuer le test, nous avons embauché le gars le plus dur que nous ayons jamais rencontré. Vérifiez le résultat!

Wir wollten die Stoßfestigkeit unseres neuen ZOWN XL180-Tisches im Vergleich zu dem billigen Tisch eines markenlosen Konkurrenten prüfen. Für den Test haben wir den härtesten Typ beauftragt, den wir je getroffen haben. Sehen die das Ergebnis!

**SHARK
GREY**



Table top and structure shark grey colour. Back, seat and structure of the chair shark grey.

Sobre y estructura de la mesa color gris oscuro azulado. Respaldo, asiento y estructura de la silla color gris oscuro azulado.

Plateau et structure de la table de couleur gris foncé bleuté. Dossier, siège et structure de la chaise couleur gris foncé bleuté.

Tischplatte und Tischgestell in Dunkelblaugrau. Rückenlehne, Sitzfläche und Gestell des Stuhls in Dunkelblaugrau.

Individual polypropylene clip to hold the leg in position when folded. Solid and durable fastening device.

Clip independiente de polipropileno para albergar la pata en posición de plegado. Fijación perfecta y duradera.

Clip indépendant de polypropylène pour maintenir le pied en position pliée. Fixation parfaite et durable.

Unabhängige Klammer aus Polypropylen zur Aufnahme des Tischbeins in Klappposition. Perfekte und dauerhafte Fixierung.

High density of vaults in the lower surface of the table top. Resistant and non-warping.

Alta densidad de bóvedas en el plano inferior del sobre. Resistente e indeformable.

Haute densité des voûtes sur le plan intérieur du plateau. Résistant et indéformable.

Zahlreiche wabenförmige Öffnungen an der Unterseite der Tischplatte. Strapazierfähig und unverformbar.

Integrated foot pads.

Tacos de las patas integrados.

Embouts des pieds intégrés.

In den Beinen integrierte Schutzkappen.

Certifications

Certificados

Certificats

Zertifikate

Zown products have been tested for professional use by independent laboratories in accordance with the following European norms. The certificates obtained are listed on each page.

Los productos Zown han sido testados para uso profesional por laboratorios independientes de acuerdo con las siguientes normativas europeas. En cada página se detallan las certificaciones obtenidas.

Les produits Zown ont été testés pour une utilisation professionnelle par des laboratoires indépendants conformément aux règlements européens suivants. Les certifications obtenues sont détaillées à chaque page.

Die Zown-Produkte wurden von unabhängigen Labors gemäß den folgenden europäischen Vorschriften für den gewerblichen Einsatz getestet. Auf jeder Seite ist die erhaltene Bewertung angegeben.



EN 581-1

Outdoor furniture - Seating and tables for camping, domestic and **contract use** - Part 1: General safety requirements.

Mobiliario de exterior. Asientos y mesas de uso doméstico, público y de camping. Parte 1: Requisitos generales de seguridad.

Mobilier d'extérieur - Sièges et tables à usage domestique, **collectif** et de camping - Partie 1 : Exigences générales de sécurité.

Außenmöbel. Sitzmöbel und Tische für den Camping-, Wohn- und Objektbereich. Teil 1: Allgemeine Sicherheitsanforderungen.



EN 581-2

Outdoor furniture - Seating and tables for camping, domestic and **contract use** - Part 2: Mechanical safety requirements and test methods for seating.

Mobiliario de exterior. Asientos y mesas de uso doméstico, público y de camping. Parte 2: Requisitos mecánicos de seguridad y métodos de ensayo para asientos.

Mobilier d'extérieur - Sièges et tables à usages domestique, **collectif** et de camping - Partie 2: Exigences de sécurité, de résistance et de durabilité pour les sièges.

Außenmöbel. Sitzmöbel und Tische für den Camping-, Wohn- und Objektbereich. Teil 2: Mechanische Sicherheitsanforderungen und Prüfverfahren für Sitzmöbel.



EN 581-3

Outdoor furniture - Seating and tables for camping, domestic and **contract use** - Part 3: Mechanical safety requirements for tables.

Mobiliario de exterior. Asientos y mesas de uso doméstico, público y de camping. Parte 3: Requisitos de seguridad mecánica para mesas.

Mobilier d'extérieur - Sièges et tables à usages domestique, **collectif** et de camping - Partie 3 : Exigences mécaniques de sécurité pour les tables.

Außenmöbel. Sitzmöbel und Tische für den Camping-, Wohn- und Objektbereich. Teil 3: Mechanische Sicherheitsanforderungen für Tische.



EN 15372

Furniture - Strength, durability and safety - Requirements for non-domestic tables. L1: Moderate - **L2: General.**

Mobiliario. Resistencia, durabilidad y seguridad. Requisitos para mesas de uso no doméstico. L1: Moderado - L2: General.

Ameublement - Résistance, durabilité et sécurité - Exigences applicables aux tables à usage non domestique. L1: Modéré - **L2: Général.**

Möbel. Festigkeit, Dauerhaltbarkeit und Sicherheit. Anforderungen an Tische für den Nicht-Wohnbereich. L1: Mäßig - L2: Allgemein.



EN 16139

Furniture - Strength, durability and safety - Requirements for non-domestic seating. **L1: General** - L2: Extreme.

Mobiliario. Resistencia, durabilidad y seguridad. Requisitos para asientos de uso no doméstico. L1: General - L2: Extremo.

Mobilier - Résistance, durabilité et sécurité - Exigences applicables aux sièges à usage collectif. **L1: Général** - L2: Extrême.

Möbel. Festigkeit, Dauerhaltbarkeit und Sicherheit. Anforderungen an Sitzmöbel für den Nicht-Wohnbereich. L1: Allgemein - L2: Extrem.



EN 16121

Non-domestic storage furniture - Requirements for safety, strength, durability and stability.

Mobiliario de almacenamiento de uso no doméstico. Requisitos de seguridad, resistencia, durabilidad y estabilidad.

Meubles de rangement à usage collectif - Exigences pour la sécurité, la résistance, la durabilité et la stabilité.

Behältnismöbel für den Nicht-Wohnbereich. Anforderungen an die Sicherheit, Festigkeit, Dauerhaltbarkeit und Standsicherheit.



RESISTANCE TO ARTIFICIAL WEATHERING

ENVEJECIMIENTO ARTIFICIAL

VIELLISSEMENT ARTIFICIEL

KÜNSTLICHE ALTERUNG

UNE EN ISO 4892-3: Plastics. Methods of exposure to laboratory light sources. Part 3: Fluorescent UV lamps. Method A. Cycle number 1.

UNE EN ISO 4892-3: Plásticos. Métodos de exposición a fuentes luminosas de laboratorio. Parte 3: Lámparas UV fluorescentes. Método A. Ciclo 1.

UNE EN ISO 4892-3 : Plastiques. Méthodes d'exposition à des sources lumineuses de laboratoire. Partie 3 : Lampes UV fluorescentes. Méthode A. Cycle 1.

DIN EN ISO 4892-3: Kunststoffe. Künstliches Bestrahlen oder Bewittern in Geräten. Teil 3: UV-Leuchtstofflampen. Methode A. Zyklus 1.

The specimens are cycled through periods of dry UV exposure (8h), UV-A340 lamps, followed by periods of condensation exposure without radiation (4h), for a total of 1500 hours.

Results after 1500 hours:

No visible appearance change. Neither changes of colour or gloss detected nor surface defects of any kind such as chalk, blisters, cracking, fissures,...etc are detected.

El ensayo consiste en ciclos de exposición que alternan periodos de radiación en seco (8h), lámparas UV-A340, con periodos de condensación sin luz (4), durante un total de 1500h.

Resultados después de 1500 horas:

Sin cambio visible de aspecto. No se detectan cambios de color o brillo ni defectos superficiales de ningún tipo tales como caleo, ampollas, grietas, fisuras,...etc

Le test consiste en des cycles d'exposition alternant des périodes de radiation à sec (8h), à des lampes UV-A340, avec des périodes de condensation sans lumière (4), durant un total de 1500 h.

Résultats au bout de 1500 heures :

Sans changement visible d'aspect. Aucune détection de changements de couleur ou de brillance ni de défauts superficiels d'aucune sorte comme de la craie, des ampoules, des craquelures, des fissures,...etc

Der Test besteht aus einer insgesamt 1500 Stunden dauernden zyklischen Belastung, in der sich Perioden trockener Bestrahlung (8 Std.) mit UV-A340-Lampen und unbeleuchtete Kondensationsperioden (4 Std.) abwechseln.

Ergebnisse nach 1500 Stunden:

Keine merkliche Änderung im Aussehen. Keine Änderungen in Farbe oder Glanz und keine Oberflächenfehler irgendeiner Art, wie Abkreiden, Blasen, Risse, Spalten etc.



RESISTANCE TO DRY HEAT

RESISTENCIA AL CALOR SECO

RÉSISTANCE À LA CHALEUR SÈCHE

BESTÄNDIGKEIT GEGEN TROCKENE HITZE

UNE EN 12722: Furniture. Assessment of the surface resistance to dry heat.

UNE EN 12 722. Mobiliario. Evaluación de la resistencia de la superficie al calor seco.

UNE EN 12722. Meubles. Évaluation de la résistance de la surface à la chaleur sèche.

UNE EN 12722. Möbel. Bewertung der Beständigkeit von Oberflächen gegen trockene Hitze.

A standard aluminium alloy block built according to the instructions in UNE EN 12722 is preheated at specified test temperature, and then put over directly on the surface to be tested for 20 minutes.

After this time, the surface is cleaned using a soft tissue and kept at room temperature for at least 16 hours.

Test result:

Up to 120°C. The sample achieved the highest classification due no change of any type is detected. The test area is not unlike the adjacent surrounding area.



Un bloque de aleación de aluminio normalizado y con la base mecanizada de acuerdo con las indicaciones de la norma UNE EN 12722 se calienta a la temperatura de ensayo, y a continuación se deposita directamente sobre la superficie a ensayar durante 20 minutos.

Al cabo de este tiempo se limpia la superficie mediante un tejido blando y se mantiene a temperatura ambiente durante al menos 16 horas.

Resultado del test:

Hasta 120°C. La muestra consigue la clasificación más alta ya que no se detecta ningún cambio en la muestra. El área de prueba queda exactamente igual a la zona adyacente.

Un bloc d'alliage d'aluminium normalisé et avec la base mécanisée conformément aux indications de la norme UNE EN 12722 se chauffe à la température de test, et est ensuite déposé directement sur la surface à tester pendant 20 minutes.

Une fois ce temps écoulé, la surface est nettoyée avec un chiffon mou et est maintenue à température ambiante pendant au moins 16 heures.

Résultat du test :

Jusqu'à 120°C. L'échantillon obtient la classification la plus haute car aucun changement n'est détecté dans l'échantillon. La surface de test reste exactement égale à la zone adjacente.

Ein Standard-Aluminiumlegierungsblock mit maschinell bearbeiteter Basis gemäß den Anforderungen der Norm UNE EN 12722 wird auf Prüftemperatur erhitzt und anschließend 20 Minuten lang direkt auf die Prüfoberfläche gelegt.

Nach diesem Zeitraum wird die Oberfläche mit einem weichen Tuch gereinigt und mindestens 16 Stunden auf Zimmertemperatur gehalten.

Prüfergebnis:

Bis 120 °C. Die Probe wird in die höchste Klasse eingestuft, da keine Änderung an der Probe festzustellen ist. Die Prüfläche ist genau gleich der benachbarten Fläche.

CHEMICAL TEST

TEST QUÍMICO

TEST CHIMIQUE

CHEMISCHE PRÜFUNG

Inspection concerning:

PAH specified in AfPS GS 2014:01 PAK.

Heavy metals (Migration of certain elements) specified in MSZ EN ISO 17294-2:2005, EN 71-3:2013+A2:2017, 2009/48/EC.

Phthalates specified in CPSC-CH-C 1001-09.3 /2010.

Test result:

The submitted table XL180 COMPLIES WITH the respecting requirements.

Se analiza la presencia de:

Hidrocarburo aromático policíclico (HAP) AfPS GS 2014:01 PAK.

Metales pesados (migración de ciertos elementos) MSZ EN ISO 17294-2:2005, EN 71-3:2013+A2:2017, 2009/48/EC.

Ftalatos CPSC-CH-C 1001-09.3 /2010.

Resultado del test:

La mesa XL180 CUMPLE con los requisitos correspondientes.

Analyse de la présence de :

Hydrocarbure aromatique polycyclique (HAP) AfPS GS 2014:01 PAK

Métaux lourds (Migration de certains éléments) MSZ EN ISO 17294-2:2005, EN 71-3:2013+A2:2017, 2009/48/EC.

Phthalates CPSC-CH-C 1001-09.3 /2010

Résultat du test :

La table XL180 RESPECTE les spécifications exigées.

Analysiert wird das Vorliegen von:

Polyzyklischen aromatischen Kohlenwasserstoffen (PAK) AfPS GS 2014:01 PAK

Schwermetallen (Migration bestimmter Elemente) MSZ EN ISO 17294-2:2005, EN 71-3:2013+A2:2017, 2009/48/EG.

Phtalaten CPSC-CH-C 1001-09.3 /2010

Prüfergebnis:

Der Tisch XL180 ERFÜLLT die entsprechenden Anforderungen.



RESISTANCE TO CORROSION IN SALT SPRAY TEST

TEST DE RESISTENCIA A LA CORROSIÓN · NIEBLA SALINA

TEST DE RÉSISTANCE À LA CORROSION · BROUILLARD SALIN

KORROSIONSPRÜFUNG · SALZSPRÜHNEBEL

UNE-EN ISO 9227:2017 according to criteria of the furniture standard UNE 11022-1:1992.

Test Method:

Sample is placed into a salt fog chamber that sprays a solution of sodium chloride. After the exposure period of 500 hours, samples are rinsed and dried in a stream of air, and the deterioration occurred on the surface of the material is examined carefully. Assessment of the sample according to cross cutting. The appearance of the test area is observed according to the following scale:

UNE- EN ISO 9227:2017 según criterios norma mobiliario UNE 11022-1:1992.

Método de Ensayo:

La muestra se coloca en una cámara de niebla salina que pulveriza sobre las muestras de ensayo una disolución de cloruro sódico. Transcurrido el tiempo de exposición de 500h, se enjuaga y se seca la muestra para examinar el deterioro producido. Valoración de la muestra según corte cruzado. Se valora el resultado según la siguiente escala:

UNE- EN ISO 9227:2017 selon les critères de la norme pour le mobilier UNE 11022-1:1992.

Méthode de test:

L'échantillon est placé dans une chambre de brouillard salin qui pulvérise une solution de chlorure de sodium sur les échantillons d'essai. Une fois écoulé le temps d'exposition de 500h, l'échantillon est rincé et séché pour examiner la détérioration produite. Évaluation de l'échantillon selon une coupe transversale. Le résultat est évalué selon l'échelle suivante:

UNE – EN ISO 9227:2017 entsprechend den Kriterien der Möbelnorm UNE 11022-1:1992.

Prüfverfahren:

Der Prüfkörper wird in eine Salznebelkammer gelegt, in der die Prüfkörper mit einer Natriumchloridlösung besprüht werden. Nach der Einwirkungsdauer von 500 Stunden wird der Prüfkörper abgespült und getrocknet und auf entstandene Schäden untersucht. Bewertung des Prüfkörpers mittels Gitterschnitt. Das Ergebnis wird nach der folgenden Skala bewertet:

APPEARANCE / ASPECTO / ASPECT / AUSSEHEN

RATING / VALORACIÓN / ÉVALUATION / BEWERTUNG

- Cuts are smooth, no finish removed, excepts for small chips at the intersections of the cuts and occasional small chip along the cut.

- Cortes lisos y uniformes, sin saltos de revestimiento, excepto pequeñas astillas en las intersecciones de los cortes y ocasionalmente a lo largo del corte.

- Coupes lisses et régulières, sans sauts de revêtement, à l'exception de petits éclats aux intersections des coupes et occasionnellement le long de la coupe.

- Glatte und gleichförmige Schnitte ohne Abplatzen der Beschichtung mit Ausnahme kleiner Splitter an den Kreuzungspunkten der Schnitte und gelegentlich entlang des Schnittes.

- Finish removed at intersections and intermittently along the cuts.

- Desaparición del revestimiento en las intersecciones e intermitentemente a lo largo de los cortes.

- Disparition du revêtement aux intersections et par intermittence le long des coupes.

- Verschwinden der Beschichtung an den Kreuzungspunkten und intermittierend entlang der Schnitte.

- Finish consistently removed along the cuts.

- Generalizada eliminación del revestimiento a lo largo de los cortes.

- Élimination généralisée du revêtement le long des coupes.

- Allgemeines Verschwinden der Beschichtung entlang der Schnitte.

- Finish removed along the cuts and completely from one or more of the squares, but from less than 50% of them.

- Eliminación completa del recubrimiento a lo largo de los cortes y de uno algunos de los cuadrillos (menos del 50%).

- Élimination complète du revêtement le long des coupes et d'un des carrés (moins de 50 %).

- Vollständiges Verschwinden der Beschichtung entlang der Schnitte sowie in einigen Feldern (weniger als 50 %).

- Finish removed completely from more than 50% of the squares.

- Eliminación total en más de un 50% de los cuadrillos.

- Élimination totale dans plus de 50% des carrés.

- Vollständiges Verschwinden der Beschichtung in mehr als 50 % der Felder.

Test result: No adhesion coating defects. Cross cut rating: 5. See table.

Resultados del test tras 500h de exposición: Sin defectos de adherencia del recubrimiento. Valoración del corte cruzado: Grado 5. Ver tabla superior.

Résultats du test après 500h d'exposition: Aucun défaut d'adhérence du revêtement. Évaluation de la coupe transversale: Grade 5. Voir tableau.

Ergebnisse der Prüfung nach 500 Stunden Einwirkung: Ohne Mängel in der Haftfestigkeit der Beschichtung. Bewertung des Gitterschnitts: Grad 5. Siehe Tabelle.

Compositions

Composiciones

Compositions

Zusammenstellungen

The XL system is a set of tables 30" nominal wide (see exact measurements on each product page) which can be joined and combined to make multiple and diverse configurations. The XL system is specially designed for events in which optimising the available space constitutes a priority.

The XXL system offers the same versatility but with tables 36" wide. The spacious XXL system makes for more elaborate arrangements as well as affording maximum comfort to table guests. The flexibility of the XL and XXL facilitates their adaptation to the unique attributes of every event.

El sistema XL es un conjunto de mesas con un ancho de 76 cm nominales (ver medidas exactas en cada página de producto) que se pueden unir y combinar para formar múltiples y variadas configuraciones. El sistema XL está especialmente indicado para aquellos eventos donde optimizar el espacio disponible es un factor clave.

El sistema XXL ofrece la misma versatilidad pero con mesas con un ancho de 90 cm nominales (ver medidas exactas en cada página de producto). El espacioso sistema XXL permite decoraciones de mayor vistosidad, además de otorgar excelente confort a los comensales. La flexibilidad de los sistemas XL y XXL permite adaptarse a las singularidades de cada evento.

Le système XL est un ensemble de tables d'une largeur nominale de 76 cm (voir dimensions exactes sur chaque page de produit) que l'on peut assembler et combiner selon des configurations multiples et variées. Le système XL est particulièrement indiqué pour les événements où l'optimisation de l'espace disponible est un facteur clé.

Le système XXL offre la même polyvalence mais avec des tables de 90 cm de largeur nominale (voir dimensions exactes sur chaque page de produit). Le système XXL, particulièrement spacieux, permet non seulement un type de décoration plus élégante mais assure également un confort d'excellente qualité pour les convives. La flexibilité des systèmes XL et XXL permet de s'adapter aux singularités de chaque événement.

Das System XL besteht aus Tischen mit einer Breite von 76 cm (genaue Abmessungen siehe jeweilige Produktseite), die auf verschiedenste Weise und in unterschiedlichsten Konfigurationen kombiniert werden können. Das System XL ist besonders für jene Anlässe geeignet, in denen es auf die optimale Nutzung des verfügbaren Raumes ankommt.

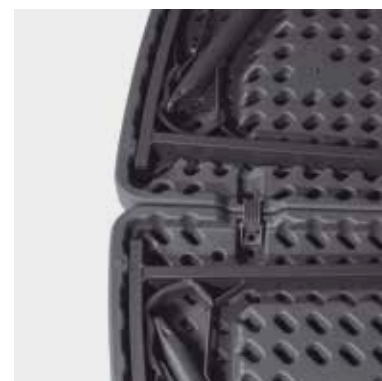
Das System XXL bietet die gleiche Vielseitigkeit jedoch mit einer Tischbreite von 90 cm (genaue Abmessungen siehe jeweilige Produktseite). Das großzügige System XXL erlaubt eine aufwändigere Dekoration und bietet den Gästen einen besonderen Komfort. Die Flexibilität der Systeme XL und XXL ermöglicht es, die Besonderheiten der jeweiligen Veranstaltung zu berücksichtigen.



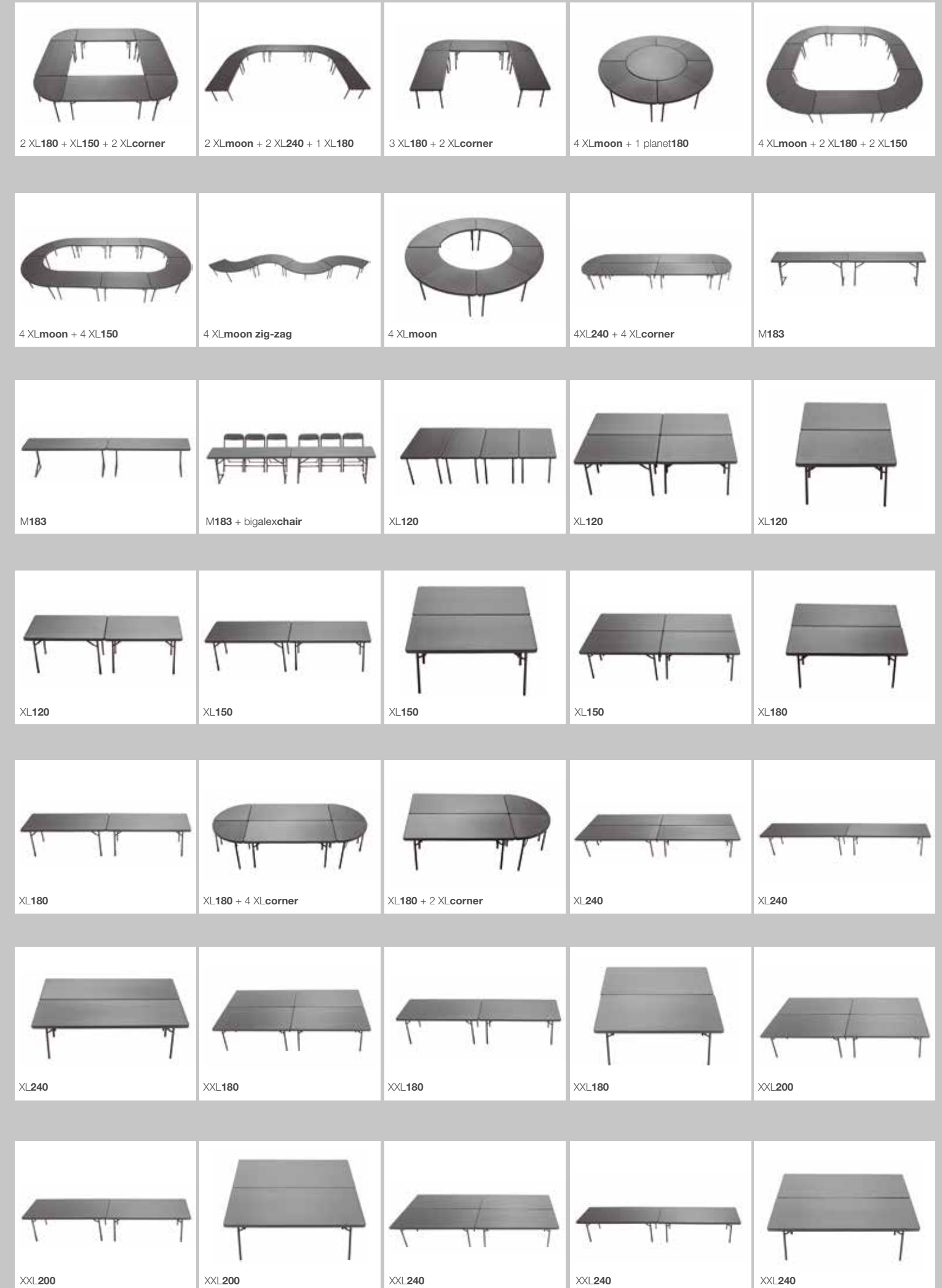
Transverse / longitudinal table joining system
Sistema de unión transversal / longitudinal
Système d'assemblage transversal / longitudinal
Querverbindingssystem / Längsverbindingssystem



Angular table joining system
Sistema de unión angular
Système d'assemblage angulaire
Eckverbindingssystem



Circular table joining system
Sistema de unión circular
Système d'assemblage circulaire
Kreisförmiges Verbindungssystem



ZOWN

thetextilecollection

The Zown Textile Collection comprises a range of standard furniture covers especially designed to fit each of New zown classic products. A broad spectrum of styles and solid colours are available. This Textile Collection is set apart by:

- Styles fully in line with New zown classic product range of furniture.
- Fabrics and weights which have been selected to strike the perfect balance between performance, aesthetics and durability.
- Special stitching designed to create strong seams and fray-resistant edges in order to withstand wear and tear.
- Crease-resistant fabrics, which are easy to wash and iron, retaining their shape and with no shrinkage.
- Stretch fabric containing 10% Lycra, which is elastic and returns to its original shape without any deformation.

La Collection Textile Zown est constituée d'une gamme de housses de meubles standard, spécialement conçues pour s'adapter à chaque produit New zown classic. Un large choix de styles et de couleurs unies est disponible. Cette Collection Textile se distingue grâce aux éléments suivants:

- Styles en accord parfait avec la gamme de meubles New zown classic.
- Tissus et poids pensés pour obtenir l'équilibre parfait entre performance, esthétique et durabilité.
- Mode de fabrication spécialement mis au point pour obtenir des coutures durantes et des bords qui ne s'effilochent pas, afin de résister à l'usure naturelle.
- Tissus anti-plis, faciles à laver et à repasser, qui conservent leur forme et ne rétrécissent pas.
- Tissu stretch contenant 10% de lycra : élastique, il reprend sa forme d'origine sans aucune déformation.

La colección textil de Zown comprende toda una gama de fundas para muebles estándar especialmente diseñada para que se adapte a todos y cada uno de los productos de la colección New zown classic. Disponibles en un amplio abanico de estilos y colores sólidos, los artículos de esta colección se distinguen por:

- Patrones perfectamente ajustados a la colección de muebles New zown classic.
- Las telas y sus gramajes han sido seleccionados para lograr el equilibrio perfecto entre rendimiento, estética y durabilidad.
- Costuras especialmente confeccionadas para crear uniones fuertes que soporten bien los tirones y bordes resistentes que no se deshilachen.
- Tejidos resistentes a las arrugas y fáciles de lavar y planchar. Mantienen su forma sin encogerse.
- Tejidos stretch con un 10% de lycra, les dota de elasticidad y les permite recuperar su forma original sin deformarse.

Die Textil-Kollektion von Zown beinhaltet verschiedene Standard-Hussen, die speziell den einzelnen New-Zown-Classic-Produkten angepasst sind. Zur Auswahl steht eine breite Palette an Modellen und beständigen Farben. Die Textil-Kollektion besticht durch folgende Merkmale:

- Die Modelle sind vollständig auf die New-Zown-Classic-Möbel abgestimmt.
- Die Stoffe und Stärken zielen auf ein perfektes Gleichgewicht aus Leistung, Ästhetik und Strapazierfähigkeit.
- Verschleißbeständige Spezialnähte für dauerhaft feste Säume und fransenlose Ränder.
- Pflegeleichte, faltenbeständige Stoffe, die ihre Form beim Waschen und Bügeln behalten und nicht eingehen.
- Elastischer Stretch-Stoff mit 10% Lycra, nimmt ohne Verziehen wieder seine Ausgangsform ein.

White - **Blanco**
Blanc - **Weiß**

Black - **Negro**
Noir - **Schwarz**

White - **Blanco**
Blanc - **Weiß**

Black - **Negro**
Noir - **Schwarz**

Ecu - **Blanco roto**
Blanco roto - **Blanco roto**

Burgundy - **Burdeos**
Bordeaux - **Bordeaux**

Ecu - **Blanco roto**
Blanco roto - **Blanco roto**

Burgundy - **Burdeos**
Bordeaux - **Bordeaux**

Sand - **Arena**
Sable - **Sand**

Red - **Rojo**
Rouge - **Rot**

Sand - **Arena**
Sable - **Sand**

Blue - **Azul**
Bleu - **Blau**

Anthracite - **Antracita**
Anthracite - **Anthrazit**

Anthracite - **Antracita**
Anthracite - **Anthrazit**

Special features

Características especiales

Caractéristiques spéciales

Besondere merkmale



Indelible label sewn to the product which clearly indicates its name and use for rapid identification and classification, thereby avoiding confusion and time-wasting.

Etiquetas indelebles cosidas al producto que indican claramente su nombre y utilidad para una rápida identificación y clasificación, evitando desórdenes y pérdidas de tiempo.

Étiquettes indélébiles cousues aux produits indiquant clairement leur nom et leur utilité pour une identification et un tri rapides, évitant ainsi désordres et pertes de temps.

Am Produkt festgenähte, unlöschbare Etiketten mit klarer Angabe des Namens und Verwendungszwecks für eine rasche Identifikation und Sortierung, um Verwirrung und unnötigen Zeitaufwand zu vermeiden.



Crease-resistant fabrics, which are easy to wash and iron, retaining their shape and with no shrinkage.

Tejidos resistentes a las arrugas y fáciles de lavar y planchar. Mantienen su forma sin encogerse.

Tissus anti-plis, faciles à laver et à repasser, qui conservent leur forme et ne rétrécissent pas.

Pflegeleichte, faltenbeständige Stoffe, die ihre Form beim Waschen und Bügeln behalten und nicht eingehen.



Special stitching designed to create strong seams and fray-resistant edges in order to withstand wear and tear.

Costuras especialmente confeccionadas para crear uniones fuertes que soporten bien los tirones y bordes resistentes que no se deshilachen.

Mode de fabrication spécialement mis au point pour obtenir des coutures durantes et des bords qui ne s'effilochent pas, afin de résister à l'usure naturelle.

Verschleißbeständige Spezialnähte für dauerhaft feste Säume und fransenlose Ränder.

Attractive packaging which clearly identifies its content and use, facilitating its classification, display and storage.

Embalajes atractivos que identifican claramente su contenido y utilidad, facilitando su clasificación, exposición y conservación.

Emballages attrayants qui permettent d'identifier clairement leur contenu et l'utilité des produits, facilitant ainsi leur tri, leur exposition et leur entreposage.

Attraktive Verpackungen mit klarer Angabe von Inhalt und Verwendungszweck zur einfacheren Sortierung, Ausstellung und Aufbewahrung.

All our textiles made in Turkey bear the **STANDARD 100 by OEKO-TEX®** certification. This label guarantees that all the components (yarns, labels, polyester, elastane, etc.) have been tested for harmful substances and therefore **the product is very safe and secure.**

Todos nuestros textiles fabricados en Turquía están certificados con la etiqueta STANDARD 100 OEKO-TEX®. Esta etiqueta garantiza que todos los componentes (hilos, etiquetas, poliéster, elastano...) han sido probados para detectar sustancias nocivas y que por lo tanto el producto es altamente seguro y confiable.

Tous nos textiles fabriqués en Turquie sont certifiés par le label **STANDARD 100 OEKO-TEX®**. Ce label garantit que tous les composants (fils, étiquettes, polyester, élasthanne...) ont été testés pour détecter les substances nocives et que **le produit est donc hautement sûr et fiable.**

Alle unsere in der Türkei hergestellten Textilien verfügen über das Zertifikat STANDARD 100 OEKO-TEX®. Dieses Etikett gewährleistet, dass alle Komponenten (Garne, Etiketten, Polyester, Elasthan ...) auf Schadstofffreiheit geprüft wurden und das Produkt daher besonders sicher und zuverlässig ist.



Styles Estilos Styles Stile

Full Table, Bench and Top Cover Shapes

stretch

87% PES 13% ELASTAN



160 g/m²

White - **Blanco**
Blanc - **Weiß**
Ecrú - **Crudo**
Écrú - **Crementeiß**

Black - **Negro**
Noir - **Schwarz**

200 g/m²

Sand - **Arena**
Sable - **Sand**
Anthracite - **Antracita**
Anthracite - **Anthrazit**
Red - **Rojo**
Rouge - **Rot**
Burgundy - **Burdeos**
Bordeaux - **Bordeaux**

paramount

100% PES



140 g/m²

White - **Blanco**
Blanc - **Weiß**
Ecrú - **Crudo**
Écrú - **Crementeiß**

Black - **Negro**
Noir - **Schwarz**

225 g/m²

Sand - **Arena**
Sable - **Sand**
Anthracite - **Antracita**
Anthracite - **Anthrazit**
Blue - **Azul**
Bleu - **Blau**
Burgundy - **Burdeos**
Bordeaux - **Bordeaux**

plain

100% PES



140 g/m²

White - **Blanco**
Blanc - **Weiß**
Ecrú - **Crudo**
Écrú - **Crementeiß**

Black - **Negro**
Noir - **Schwarz**

225 g/m²

Sand - **Arena**
Sable - **Sand**
Anthracite - **Antracita**
Anthracite - **Anthrazit**
Blue - **Azul**
Bleu - **Blau**
Burgundy - **Burdeos**
Bordeaux - **Bordeaux**

bridge

100% PES



140 g/m²

White - **Blanco**
Blanc - **Weiß**
Ecrú - **Crudo**
Écrú - **Crementeiß**

Black - **Negro**
Noir - **Schwarz**

225 g/m²

Sand - **Arena**
Sable - **Sand**
Anthracite - **Antracita**
Anthracite - **Anthrazit**
Blue - **Azul**
Bleu - **Blau**
Burgundy - **Burdeos**
Bordeaux - **Bordeaux**

Partial Table Skirt

paramount

100% PES



140 g/m²

White - **Blanco**
Blanc - **Weiß**
Ecrú - **Crudo**
Écrú - **Crementeiß**

Black - **Negro**
Noir - **Schwarz**

225 g/m²

Sand - **Arena**
Sable - **Sand**
Anthracite - **Antracita**
Anthracite - **Anthrazit**
Blue - **Azul**
Bleu - **Blau**
Burgundy - **Burdeos**
Bordeaux - **Bordeaux**

Chair Cover Shapes

stretch

87% PES 13% ELASTAN



160 g/m²

White - **Blanco**
Blanc - **Weiß**
Ecrú - **Crudo**
Écrú - **Crementeiß**

Black - **Negro**
Noir - **Schwarz**

200 g/m²

Sand - **Arena**
Sable - **Sand**
Anthracite - **Antracita**
Anthracite - **Anthrazit**
Red - **Rojo**
Rouge - **Rot**
Burgundy - **Burdeos**
Bordeaux - **Bordeaux**

classic

100% PES



140 g/m²

White - **Blanco**
Blanc - **Weiß**
Ecrú - **Crudo**
Écrú - **Crementeiß**

Black - **Negro**
Noir - **Schwarz**

225 g/m²

Sand - **Arena**
Sable - **Sand**
Anthracite - **Antracita**
Anthracite - **Anthrazit**
Blue - **Azul**
Bleu - **Blau**
Burgundy - **Burdeos**
Bordeaux - **Bordeaux**

Chair Sash Shapes

plain

87% PES 13% ELASTAN



White - **Blanco**
Blanc - **Weiß**
Ecrú - **Crudo**
Écrú - **Crementeiß**

Sand - **Arena**
Sable - **Sand**

Anthracite - **Antracita**
Anthracite - **Anthrazit**

twist

87% PES 13% ELASTAN



Black - **Negro**
Noir - **Schwarz**

classic

87% PES 13% ELASTAN



Red - **Rojo**
Rouge - **Rot**

Burgundy - **Burdeos**
Bordeaux - **Bordeaux**

Tablecloths

tablecloths

100% CO

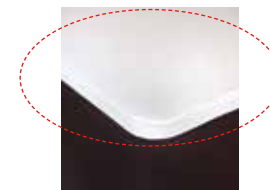


White - **Blanco**
Blanc - **Weiß**

Top Cover

stretch

87% PES 13% ELASTAN



160 g/m²

White - **Blanco**
Blanc - **Weiß**
Ecrú - **Crudo**
Écrú - **Crementeiß**

Black - **Negro**
Noir - **Schwarz**

200 g/m²

Sand - **Arena**
Sable - **Sand**
Anthracite - **Antracita**
Anthracite - **Anthrazit**
Red - **Rojo**
Rouge - **Rot**
Burgundy - **Burdeos**
Bordeaux - **Bordeaux**

Colours Colores Couleurs Farben

stretch

Table, Bench and Chair Cover Colours

87% PES 13% ELASTAN

160 g/m²



White Ecu Black

200 g/m²



Sand Anthracite Burgundy Red

paramount

Cover and Partial-Skirt Colours

100% PES

140 g/m²



White Ecu Black

225 g/m²



Sand Anthracite Burgundy Blue

plain

Cover Colours

100% PES

140 g/m²



White Ecu Black

225 g/m²



Sand Anthracite Burgundy Blue

bridge

Cover Colours

100% PES

140 g/m²



White Ecu Black

225 g/m²



Sand Anthracite Burgundy Blue

stretch

Chair Cover Colours

87% PES 13% ELASTAN

160 g/m²



White Ecu Black

200 g/m²



Sand Anthracite Burgundy Red

classic

Chair Cover Colours

100% PES

140 g/m²



White Ecu Black

225 g/m²



Sand Anthracite Burgundy Blue

chair sash

Colours

87% PES 13% ELASTAN



Colour of Cotton Tablecloths and napkins

White

Key Leyenda Légende Legende

Ten-year or five-year limited warranty for products where expressly indicated on the corresponding catalogue page. For all other products, the European two-year legal guarantee shall apply. (If purchased before 1 January 2022) or by a three-year limited warranty if purchased after that date. See conditions on www.zown.com/en/zown-warranty.

10

Garantía limitada de 10 o 5 años para aquellos productos en los que así se indique en la correspondiente página del catálogo. Para el resto de productos será aplicable la garantía legal europea de 2 años. (Si se han adquirido antes del 1 de enero de 2022) o una garantía limitada de tres años (si se han adquirido posteriormente). Consultar condiciones en www.zown.com/download-garantia.

5

10 ou 5 ans de garantie limitée pour tous les produits dont la description contient cette indication (veuillez vous reporter à la page correspondante du catalogue). Pour tous les autres produits, c'est la garantie légale européenne de deux ans qui sera appliquée. (S'ils ont été achetés avant le 1er janvier 2022) ou une garantie limitée de trois ans (s'ils ont été achetés postérieurement). Consulter les conditions sur www.zown.com/fr/garantie-zown.

Auf Waren mit der entsprechenden Angabe auf der jeweiligen Katalogseite leisten wir 10 bzw. 5 Jahre beschränkte Garantie. Für die anderen Waren gilt die gesetzliche europäische Garantiefrist von 2 Jahren. (ei Kauf vor dem 1. Januar 2022) bzw. von drei Jahren (bei Kauf danach). Bedingungen siehe www.zown.com/de/download-garantie.

SHARK
GREY

Table top and structure shark grey colour. Back, seat and structure of the chair shark grey.

Sobre y estructura de la mesa color gris oscuro azulado. Respaldo, asiento y estructura de la silla color gris oscuro azulado.

Plateau et structure de la table de couleur gris foncé bleuté. Dossier, siège et structure de la chaise couleur gris foncé bleuté.

Tischplatte und Tischgestell in Dunkelblaugrau. Rückenlehne, Sitzfläche und Gestell des Stuhls in Dunkelblaugrau.

High-density polyethylene table top, chair or bench seat and backrest. Powder-coated steel frame.

100%
PURE HDPE.
NOT MIXED

Sobre de mesa, o asiento y respaldo de silla o banco, en polietileno de alta densidad. Estructura de acero pintado por pulverización.

Plateau de table, ou siège et dossier de chaise ou de banc, en polyéthylène haute densité. Structure en acier peint par pulvérisation.

Tischplatte bzw. Sitzfläche und Rückenlehne von Stuhl bzw. Bank aus HDPE. Gestell aus pulverbeschichtetem Stahl.

100%
PP

Polypropylene chair seat and backrest. Powder-coated steel frame.

Asiento y respaldo de la silla de polipropileno. Estructura de acero pintado por pulverización.

Siège et dossier de la chaise en polypropylène. Structure en acier peint par pulvérisation.

Sitzfläche und Rückenlehne des Stuhls aus Polypropylen. Gestell aus pulverbeschichtetem Stahl.

100%
STEEL

Steel chair seat and backrest.

Asiento y respaldo de la silla de acero.

Siège et dossier de la chaise en acier.

Sitzfläche und Rückenlehne des Stuhls aus Stahl.



(*) Maximum uniformly distributed static load that the table can withstand for 24 hours without causing a permanent and severe degree of deformation that would prevent its use.

This product must only be used in accordance with the test report (European Standard, EN) indicated on the catalogue page.

(*) Carga estática máxima uniformemente repartida que puede soportar la mesa durante 24h sin causar un grado de deformación permanente y severo que impida su uso. Este producto solo debe usarse de acuerdo con el informe de pruebas (Normativa Europea, EN) que se indica en la página del catálogo.



(*) Charge statique maximale recommandée, uniformément répartie, que la table peut supporter pendant 24 heures sans provoquer un degré de déformation important qui empêcherait son utilisation.

Ce produit doit être utilisé conformément au rapport d'essai (norme européenne EN) référencé dans la page du catalogue.

(*) Während der Verwendung des Produkts darf die auf dem Etikett angegebene „gleichmäßig verteilte statische Höchstlast über 24 Stunden“ weder in Bezug auf das Gewicht noch in Bezug auf die Zeitdauer überschritten werden. Dieses Produkt darf nur in Übereinstimmung mit dem auf dem Produktetikett oder auf der Verpackung angegebenen Prüfbericht (Europäische Norm, EN) verwendet werden.



Net product weight.

Peso neto del producto.

Poids net du produit.

Nettogewicht des Artikels.



UV and water-resistant protection. Ideal for prolonged outdoor use but should not be exposed permanently or in extreme conditions (particularly high humidity or salinity levels).

Protección UV e Hidrófuga. Ideal para uso exterior prolongado pero no permanente ni extremo (especialmente humedad o salinidad alta).

Protection UV et hydrofuge. Idéal pour une utilisation extérieure prolongée mais non permanente ni en conditions extrêmes (en particulier humidité ou haute salinité).

UV-geschützt und wasserabweisend. Ideal für längere Verwendung im Außenbereich, jedoch nicht für dauerhafte Verwendung im Außenbereich oder extreme Einsatzbedingungen (insbesondere hoher Salzgehalt bzw. Feuchtigkeit) geeignet.



Seating capacity of the table.

Máximo número recomendado de comensales por mesa.

Nombre maximum recommandé de personnes par table.

Anzahl der Sitzplätze pro Tisch.



In independent laboratories, this product has passed the tests corresponding to the following regulations.

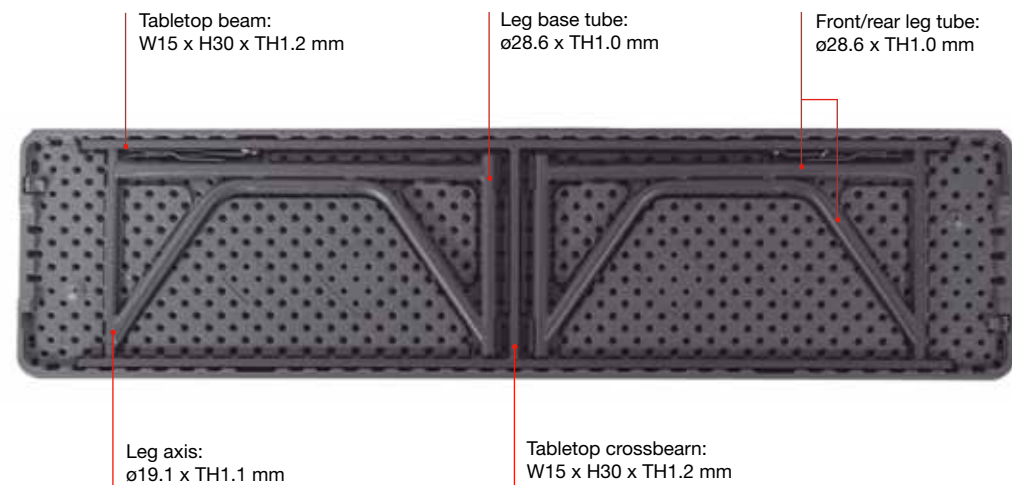
Este producto ha superado en laboratorios independientes los test correspondientes a las siguientes normativas.

Ce produit a passé avec succès dans les laboratoires les tests correspondants aux réglementations suivantes.

Dieses Produkt hat in unabhängigen Labors die Tests der folgenden Vorschriften bestanden.

M183

new zown classic

SHARK
GREY100%
PURE HDPE.
NOT MIXED581-1
581-3 Contract
15372 L2L183 x W46 cm
L72" x W18.1"

stretch



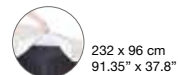
| | | | | | | | |
|-------------|------|------|------|------|------|------|------|
| table cover | 1192 | 1196 | 1194 | 1195 | 1193 | 1197 | 1198 |
| top cover | 0445 | 0844 | 0842 | 0841 | 0442 | 0843 | 0441 |



paramount



| | | | | | | | |
|-------------|------|------|------|------|------|------|------|
| table cover | 0123 | 0848 | 0847 | 0126 | 0124 | 0128 | 0127 |
| tablecloth | 0549 | | | | | | |



plain



| | | | | | | | |
|-------------|------|------|------|------|------|------|------|
| table cover | 0338 | 0846 | 0845 | 0341 | 0339 | 0343 | 0342 |
| tablecloth | 0549 | | | | | | |

232 x 96 cm
91.35" x 37.8"232 x 96 cm
91.35" x 37.8"

Longitudinal table joining system.

Sistema de unión longitudinal.

Système d'assemblage longitudinal.

Längsverbindingssystem.

Ergonomic frame design.

Diseño ergonómico de la estructura.

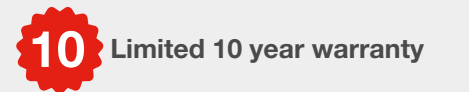
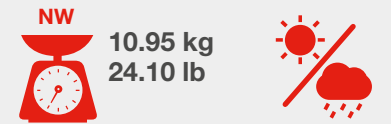
Design ergonomique de la structure.

Ergonomisches Gestelldesign.

New and very smooth manual locking mechanism. Includes automatic sliding rings to prevent undesired folding.

Nuevo bloqueador manual de manejo muy suave. Incluye argollas autodeslizantes de seguridad para evitar el plegado involuntario.

Nouveau mécanisme de blocage manuel au maniement très doux. Il inclut des anneaux autoglissant de sécurité pour éviter le pliage involontaire.

Neue, sehr leichtgängige, manuelle Verriegelung. Mit selbstgleitenden Sicherheitsringen, die ein unerwünschtes Zusammenklappen verhindern.XXL trolley available for 24 tables.
See page 72.**Carro XXL trolley disponible para 24 mesas. Ver pág. 72.**Chariot XXL trolley disponible pour 24 tables.
Voir page 72.**Wagen XXL trolley lieferbar für 24 Tische. Siehe S. 72.**Capacity: 3 persons.
Area per person: 24".**Capacidad: 3 personas. Espacio por persona: 61 cm.**Capacité: 3 personnes.
Espace par personne: 61 cm.**Bietet Platz für 3 Personen. Platz pro Person: 61 cm.**Multitrolley available for 15 tables.
See page 88.**Carro Multitrolley disponible para 15 mesas. Ver pág. 88.**Chariot Multitrolley disponible pour 15 tables.
Voir page 88.**Wagen Multitrolley lieferbar für 15 Tische. Siehe S. 88.**Code
Código
Code
Code

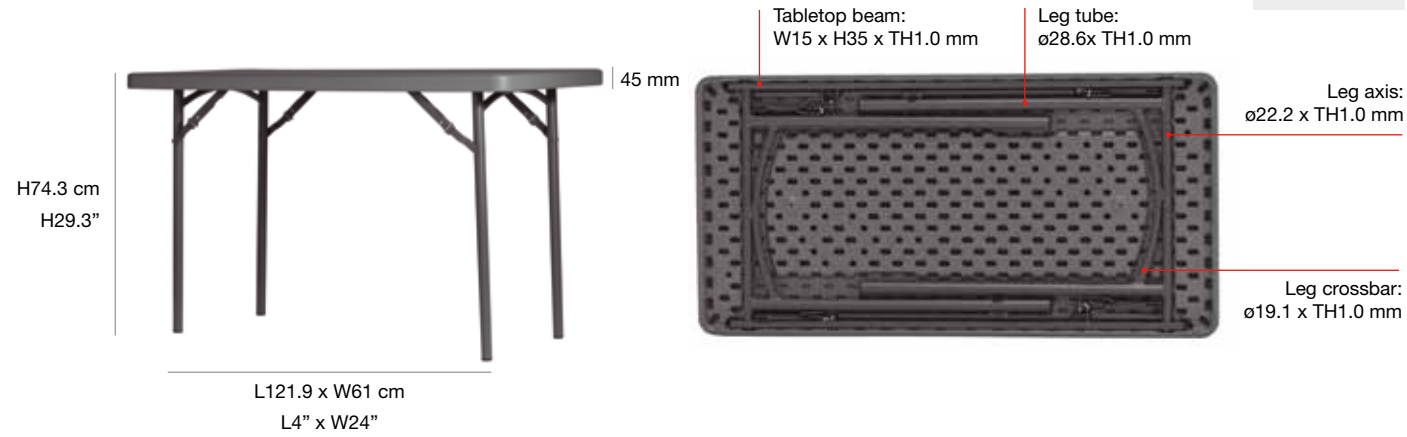
PT-033-NC

EAN 8436539306535

Name
Nombre
Nom
Name**M183**
new zown classicUnits per box
Unidades por caja
Unités par boîte
Stückzahl pro Packung

1

Packaging size
Medidas embalaje
Dimensions emballage
Verpackungsmaße185.4 x 47.6 x 6.3 cm
73" x 18.7" x 2.4"Packaging volume
Volumen embalaje
Volume d'emballage
Verpackungsvolumen0.05 m³
1.77 ft³Gross weight
Peso bruto
Poids brut
Bruttogewicht12.8 kg
28.21 lbLoading quantity
Unidades
por contenedor
Unités par conteneur
Einheiten
pro ContainerContainer 40': 1100
Container 40' HC: 1220

SHARK
GREY**L120**
new zown classic100%
PURE HDPE.
NOT MIXED581-1
581-3 Contract
15372 L2

| Code Código Code Code | EAN | Name Nombre Nom Name | Units per box Unidades por caja Unités par boîte Stückzahl pro Packung | Packaging size Medidas embalaje Dimensions emballage Verpackungsmaße | Packaging volume Volumen embalaje Volume d'emballage Verpackungsvolumen | Gross weight Peso bruto Poids brut Bruttogewicht | Loading quantity Unidades por contenedor Unités par conteneur Einheiten pro Container |
|--------------------------------|---------------|---------------------------------|---|---|--|---|--|
| BT004X015 | 8436539306559 | L120 new zown classic | 1 | 125 x 63.5 x 6 cm 49.2" x 25" x 2.4" | 0.04 m ³ 1.68 ft ³ | 10.65 kg 23.47 lb | Container 40': 1270 Container 40' HC: 1500 |



Ergonomic. Comfortable for those seated at the end of the table.

Ergonomía. Pleno confort también, para los usuarios ubicados en las cabeceras de la mesa.

Ergonomie. Confort total aussi pour les personnes situées en bout de table.

Ergonomie. Uneingeschränkter Sitzkomfort auch an der Kopfseite des Tisches.

New and very smooth manual locking mechanism. Includes automatic sliding rings.

Nuevo bloqueador manual de manejo muy suave. Incluye argollas autodeslizantes de seguridad.

Nouveau mécanisme de blocage manuel au maniement très doux. Il inclut des anneaux autoglissant de sécurité.

Neue, sehr leichtgängige, manuelle Verriegelung. Mit selbstgleitenden Sicherheitsringen.

Integrated foot pads.

Tacos de las patas integrados.

Embouts des pieds intégrés.

In den Beinen integrierte Schutzkappen.

L120 available for 20 tables. See page 33.

Carro L120 disponible para 20 mesas. Ver pág. 33.

Chariot L120 disponible pour 20 tables. Voir page 33.

Wagen L120 lieferbar für 20 Tische. Siehe S. 33.

Capacity: 4 persons. Area per person: 24" x 61 cm.

Capacidad: 4 personas. Espacio por persona: 61 cm.

Capacité: 4 personnes. Espace par personne: 61 cm.

Bietet Platz für 4 Personen. Platz pro Person: 61 cm.

Multitrolley available for 15 tables. See page 92.

Carro Multitrolley disponible para 15 mesas. Ver pág. 92.

Chariot Multitrolley disponible pour 15 tables. Voir page 92.

Wagen Multitrolley lieferbar für 15 Tische. Siehe S. 92.

stretch



table cover 0205 0852 0850 0849 0202 0851 0201

top cover 0438 0856 0854 0853 0435 0855 0434

paramount



table cover 0117 0860 0859 0120 0118 0122 0121

tablecloth 0548



172 x 131 cm
67.7" x 51.6"

plain



table cover 0332 0858 0857 0335 0333 0337 0336

tablecloth 0548



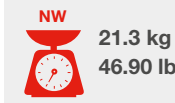
172 x 131 cm
67.7" x 51.6"

Ltrolley100%
POWDER
COATED
STEEL

16121 L2



L131.7 x W62 cm
L51.9" x W24.4"



| Code Código Code Code | EAN | Name Nombre Nom Name | Units per box Unidades por caja Unités par boîte Stückzahl pro Packung | Packaging size Medidas embalaje Dimensions emballage Verpackungsmaße | Packaging volume Volumen embalaje Volume d'emballage Verpackungsvolumen | Gross weight Peso bruto Poids brut Bruttogewicht | Loading quantity Unidades por contenedor Unités par conteneur Einheiten pro Container |
|--------------------------------|---------------|-------------------------------|---|---|--|---|--|
| RA-101A | 8437009886014 | Ltrolley | 1 | 138.4 x 72.4 x 15.2 cm 54.5" x 28.5" x 6" | 0.15 m ³ 5.36 ft ³ | 23.90 kg 52.50 lb | Container 40': 409 Container 40' HC: 440 |



Part to hold the removable posts when folded. Bar with automatic unlocking mechanism which allows the vertical bracket to be folded. Trolley in fully folded position. Occupies a minimum of space. All parts are integrated to prevent loss.

Pieza para sujetar los postes extraíbles en posición de plegado. Barra con mecanismo automático para desbloquear y permitir el plegado del soporte vertical. Carro totalmente plegado. Ocupa mínimo espacio y todos sus componentes quedan integrados para no extraviarlos.

Pièce pour les poteaux extractibles en position de pliage. Barre avec mécanisme automatique pour blocage et déblocage et pour permettre le pliage du support vertical. Chariot entièrement plié. Occupe peu de place. Tous ses composants sont intégrés pour ne pas les perdre.

Haltevorrichtung für die herausnehmbaren Stangen in abgeklappter Position. Stange mit automatischem Mechanismus zum Entriegeln und Zusammenklappen des senkrechten Gestells. Der Wagen lässt sich vollständig zusammenklappen. Platzsparend sind alle Bestandteile integriert, damit sie nicht verloren gehen.



Peripheral posts to hold the stacked tables in place.

Postes périphériques pour immobiliser les tables empilées.

Poteaux périphériques pour immobilisation des tables empilées.

Sicherungsstangen verhindern das Verrutschen der gestapelten Tische.



Handle specially designed to protect the hands.

Asa especial para proteger las manos.

Anse spécialement conçue pour protéger les mains.

Ein spezieller Griff schützt die Hände.



Capacity: 20 pcs. L120.

Capacidad: 20u. L120.

Capacité: 20u. L120.

Fassungsvermögen: 20 Stk. L120.



Four polyurethane wheels with built-in brake. (Two fixed wheels and two pivoting wheels).

4 ruedas de poliuretano con freno incorporado. (2 ruedas fijas y 2 ruedas pivotantes).

4 roues en polyuréthane avec frein intégré. (2 roulettes fixes et 2 roulettes pivotantes).

4 PU-Räder mit integrierter Bremse. (2 feststehende Räder und 2 Schwenkräder).

XL120

new zown classic

SHARK
GREY100%
PURE HDPE.
NOT MIXED581-1
581-3 Contract
15372 L2H74.3 cm
H29.25"

45 mm

L121.9 x W76 cm
L48" x W30"Tabletop beam:
W15 x H35 x TH1.0 mmLeg tube:
ø28.6 x TH1.0 mmLeg axis:
ø22.2 x TH1.0 mmLeg crossbar:
ø19.1 x TH1.0 mm

stretch



table cover 01200 01201 01202 01203 01204 01205 01206
top cover 01207 01208 01209 01210 01211 01212 01213



paramount



table cover 01385 01386 01387 01388 01389 01390 01391
tablecloth 01392

172 x 126 cm
67.7" x 49.6"

plain



table cover 01378 01379 01380 01381 01382 01383 01384

172 x 126 cm
67.7" x 49.6"

Transverse and longitudinal table joining system.

Sistema de unión transversal y longitudinal.

Système d'assemblage transversal et longitudinal.

Querbindungssystem und Längsbindungssystem.

Ergonomic. Comfortable for those seated at the end of the table.

Ergonomía. Pleno confort también, para los usuarios ubicados en las cabeceras de la mesa.

Ergonomie. Confort total aussi pour les personnes situées en bout de table.

Ergonomie. Uneingeschränkter Sitzkomfort auch an der Kopfseite des Tisches.

New and very smooth manual locking mechanism. Includes automatic sliding rings to prevent undesired folding.

Nuevo bloqueador manual de manejo muy suave. Incluye argollas autodeslizantes de seguridad para evitar el plegado involuntario.

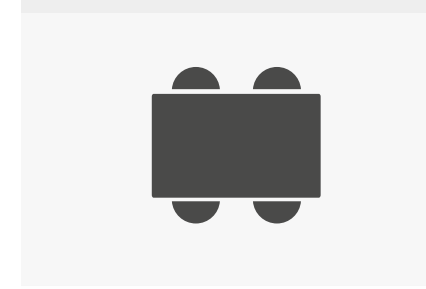
Nouveau mécanisme de blocage manuel au maniement très doux. Il inclut des anneaux autoglissant de sécurité pour éviter le pliage involontaire.

Neue, sehr leichtgängige, manuelle Verriegelung. Mit selbstgleitenden Sicherheitsringen, die ein unerwünschtes Zusammenklappen verhindern.

Integrated foot pads.

Tacos de las patas integrados.

Embouts des pieds intégrés.

In den Beinen integrierte Schutzkappen.XLtrolley available for 28 tables.
See page 52.**Carro XLtrolley disponible para 28 mesas. Ver pág. 52.**Chariot XLtrolley disponible pour 28 tables.
Voir page 52.**Wagen XLtrolley lieferbar für 28 Tische. Siehe S. 52.**Capacity: 4 persons.
Area per person: 24".**Capacidad: 4 personas. Espacio por persona: 61 cm.**Capacité: 4 personnes.
Espace par personne: 61 cm.**Bietet Platz für 4 Personen. Platz pro Person: 61 cm.**Multitrolley available for 15 tables.
See page 92.**Carro Multitrolley disponible para 15 mesas. Ver página 92.**Chariot Multitrolley disponible pour 15 tables.
Voir page 92.**Wagen Multitrolley lieferbar für 15 Tische. Siehe S. 92.**Code
Código
Code
Code

BT004X014

EAN 8436539306580

Name
Nombre
Nom
NameXL120
new zown classicUnits per box 1
Unidades por caja
Unités par boîte
Stückzahl pro PackungPackaging size 123.3 x 77.5 x 5.7 cm
Medidas embalaje 48.5" x 30.5" x 2.2"
Dimensions emballage
VerpackungsmaßePackaging volume 0.05 m³
Volumen embalaje 1.77 ft³
Volume d'emballage
VerpackungsvolumenGross weight 11.95 kg
Peso bruto 26.34 lb
Poids brut
BruttogewichtLoading quantity Container 40': 1005
Unidades por contenedor Container 40' HC: 1170
Unités par conteneur
Einheiten
pro Container



XL150

new zown classic

100%
PURE HDPE.
NOT MIXED



581-1
581-3 Contract
15372 L2

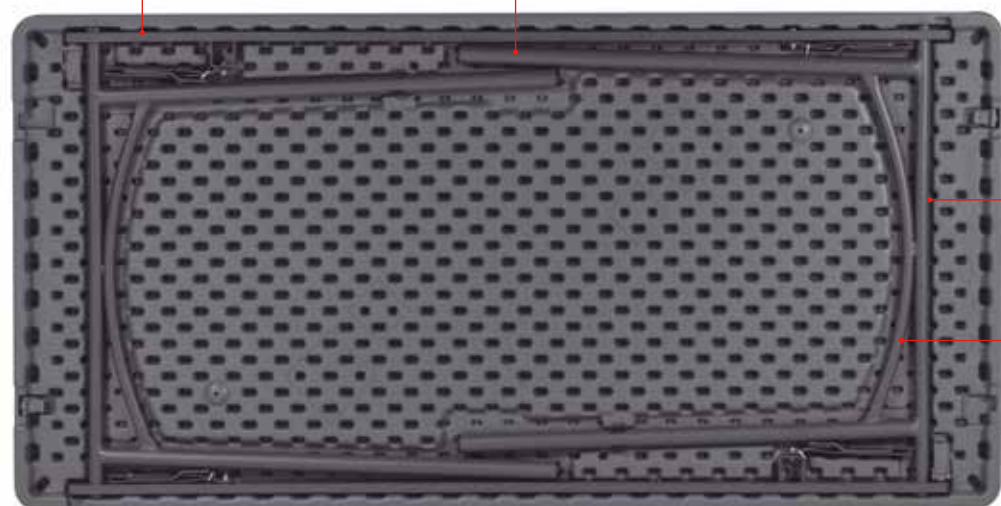
SHARK
GREY



L152.4 x W76.2 cm
L5' x W30"

Tabletop beam:
W15 x H35 x TH1.0 mm

Leg tube:
ø28.6 x TH1.0 mm



Leg axis:
ø22.2 x TH1.0 mm

Leg crossbar:
ø19.1 x TH1.0 mm

stretch



table cover 0254 0864 0862 0861 0251 0863 0250
top cover 0501 0868 0866 0865 0498 0867 0497



paramount



table cover 0165 0872 0871 0168 0166 0170 0169
tablecloth 0555



203 x 126 cm
80" x 49.6"

plain



table cover 0398 0870 0869 0401 0399 0403 0402
tablecloth 0555



203 x 126 cm
80" x 49.6"



Transverse and longitudinal table joining system.

Sistema de unión transversal y longitudinal.

Système d'assemblage transversal et longitudinal.

Querbindungssystem und Längsbindungssystem.



Ergonomic. Comfortable for those seated at the end of the table.

Ergonomía. Pleno confort también, para los usuarios ubicados en las cabeceras de la mesa.

Ergonomie. Confort total aussi pour les personnes situées en bout de table.

Ergonomie. Uneingeschränkter Sitzkomfort auch an der Kopfseite des Tisches.



New and very smooth manual locking mechanism. Includes automatic sliding rings to prevent undesired folding.

Nuevo bloqueador manual de manejo muy suave. Incluye argollas autodeslizantes de seguridad para evitar el plegado involuntario.

Nouveau mécanisme de blocage manuel au maniement très doux. Il inclut des anneaux autoglissant de sécurité pour éviter le pliage involontaire.

Neue, sehr leichtgängige, manuelle Verriegelung. Mit selbstgleitenden Sicherheitsringen, die ein unerwünschtes Zusammenklappen verhindern.

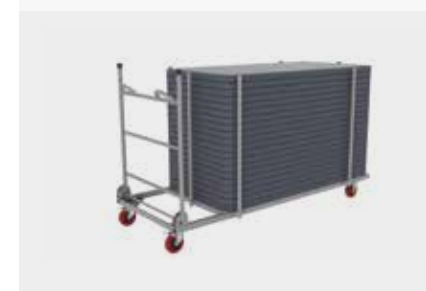


Integrated foot pads.

Tacos de las patas integrados.

Embouts des pieds intégrés.

In den Beinen integrierte Schutzkappen.

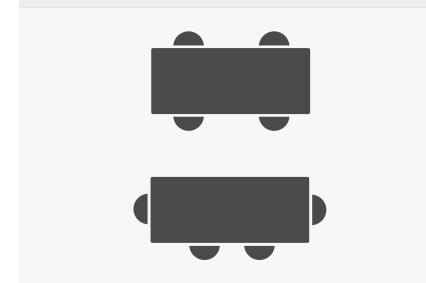


XLtrolley available for 20 tables.
See page 52.

Carro XLtrolley disponible para 20 mesas. Ver pág. 52.

Chariot XLtrolley disponible pour 20 tables.
Voir page 52.

Wagen XLtrolley lieferbar für 20 Tische. Siehe S. 52.



Capacity: 4 persons.
Area per person: 29.9".

Capacidad: 4 personas. Espacio por persona: 76 cm.

Capacité: 4 personnes.
Espace par personne: 76 cm.

Bietet Platz für 4 Personen. Platz pro Person: 76 cm.

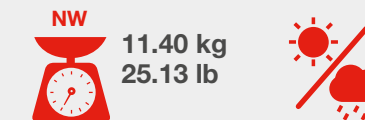


Multitrolley available for 15 tables.
See page 92.

Carro Multitrolley disponible para 15 mesas. Ver página 92.

Chariot Multitrolley disponible pour 15 tables.
Voir page 92.

Wagen Multitrolley lieferbar für 15 Tische. Siehe S. 92.



Code BT005X012
Código
Code
Code

EAN 8436539306450

Name XL150
Nombre new zown classic
Nom
Name

Units per box 1
Unidades por caja
Unités par boîte
Stückzahl pro Packung

Packaging size 155 x 77.8 x 6.4 cm
Medidas embalaje 61" x 30.6" x 2.5"
Dimensions emballage
Verpackungsmaße

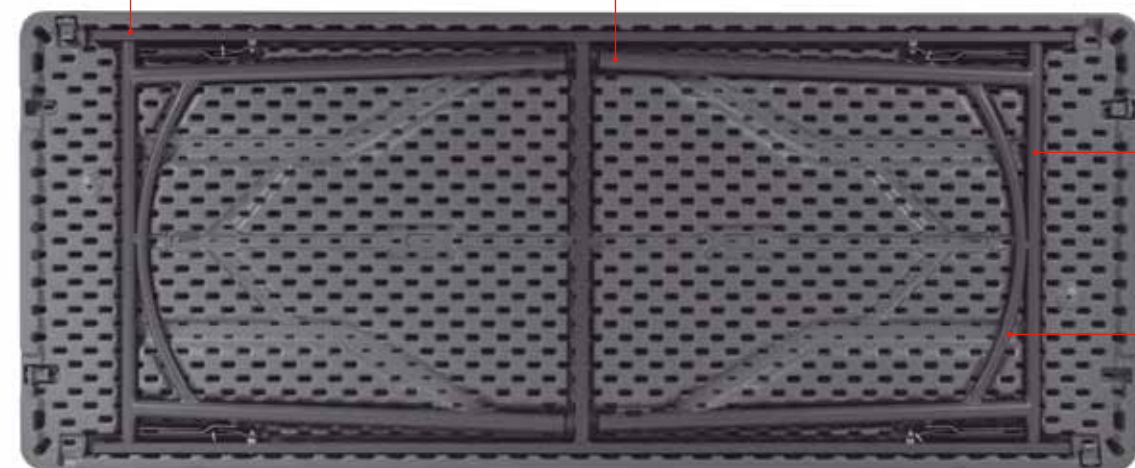
Packaging volume 0.08 m³
Volumen embalaje 2.83 ft³
Volume d'emballage
Verpackungsvolumen

Gross weight 13.37 kg
Peso bruto 29.47 lb
Poids brut
Bruttogewicht

Loading quantity Container 40': 850
Unidades por contenedor Container 40' HC: 940
Unités par conteneur
Einheiten
pro Container

XL180

new zown classic

SHARK
GREY100%
PURE HDPE.
NOT MIXED581-1
581-3 Contract
15372 L2L182.9 x W75.2 cm
L6' x W29.6"Tabletop beam:
W15 x H35 x TH1.0 mmLeg tube:
ø28.6 x TH1.0 mmLeg axis:
ø22.2 x TH1.0 mmLeg crossbar:
ø19.1 x TH1.0 mm

stretch



| | | | | | | | |
|-------------|------|------|------|------|------|------|------|
| table cover | 0261 | 0876 | 0874 | 0873 | 0258 | 0875 | 0257 |
| top cover | 0508 | 0880 | 0878 | 0877 | 0505 | 0879 | 0504 |



paramount



| | | | | | | | |
|-------------|------|------|------|------|------|------|------|
| table cover | 0171 | 0884 | 0883 | 0174 | 0172 | 0176 | 0175 |
| tablecloth | 0556 | | | | | | |

232 x 126 cm
91.3" x 49.6"

plain



| | | | | | | | |
|-------------|------|------|------|------|------|------|------|
| table cover | 0404 | 0882 | 0881 | 0407 | 0405 | 0409 | 0408 |
| tablecloth | 0556 | | | | | | |

232 x 126 cm
91.3" x 49.6"

Transverse and longitudinal table joining system.

Sistema de unión transversal y longitudinal.

Système d'assemblage transversal et longitudinal.

Querbindungssystem und Längsbindungssystem.

Ergonomic. Comfortable for those seated at the end of the table.

Ergonomía. Pleno confort también, para los usuarios ubicados en las cabeceras de la mesa.

Ergonomie. Confort total aussi pour les personnes situées en bout de table.

Ergonomie. Uneingeschränkter Sitzkomfort auch an der Kopfseite des Tisches.

New and very smooth manual locking mechanism. Includes automatic sliding rings to prevent undesired folding.

Nuevo bloqueador manual de manejo muy suave. Incluye argollas autodeslizantes de seguridad para evitar el plegado involuntario.

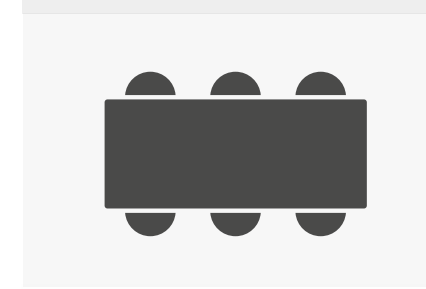
Nouveau mécanisme de blocage manuel au maniement très doux. Il inclut des anneaux autoglissant de sécurité pour éviter le pliage involontaire.

Neue, sehr leichtgängige, manuelle Verriegelung. Mit selbstgleitenden Sicherheitsringen, die ein unerwünschtes Zusammenklappen verhindern.

Integrated foot pads.

Tacos de las patas integrados.

Embouts des pieds intégrés.

In den Beinen integrierte Schutzkappen.XLtrolley available for 20 tables.
See page 52.**Carro XLtrolley disponible para 20 mesas. Ver pág. 52.**Chariot XLtrolley disponible pour 20 tables.
Voir page 52.**Wagen XLtrolley lieferbar für 20 Tische. Siehe S. 52.**Capacity: 6 persons.
Area per person: 24".**Capacidad: 6 personas. Espacio por persona: 61 cm.**Capacité: 6 personnes.
Espace par personne: 61 cm.**Bietet Platz für 6 Personen. Platz pro Person: 61 cm.**Multitrolley available for 14 tables.
See page 92.**Carro Multitrolley disponible para 14 mesas. Ver página 92.**Chariot Multitrolley disponible pour 14 tables.
Voir page 92.**Wagen Multitrolley lieferbar für 14 Tische. Siehe S. 92.**

6

362 kg
800 lb24 hours
(*) p. 3112.90 kg
28.43 lb

Limited 10 year warranty

Code
Código
Code
Code

BT006X020

EAN 8436539306467

Name
Nombre
Nom
NameXL180
new zown classicUnits per box
Unidades por caja
Unités par boîte
Stückzahl pro Packung

1

Packaging size
Medidas embalaje
Dimensions emballage
Verpackungsmaße184.5 x 76.8 x 5.7 cm
72.6" x 30.2" x 2.2"Packaging volume
Volumen embalaje
Volume d'emballage
Verpackungsvolumen0.08 m³
2.83 ft³Gross weight
Peso bruto
Poids brut
Bruttogewicht15.25 kg
33.62 lbLoading quantity
Unidades
por contenedor
Unités par conteneur
Einheiten
pro ContainerContainer 40': 700
Container 40' HC: 800

TABLE
MESA
TABLE
TISCH

XL180vintage

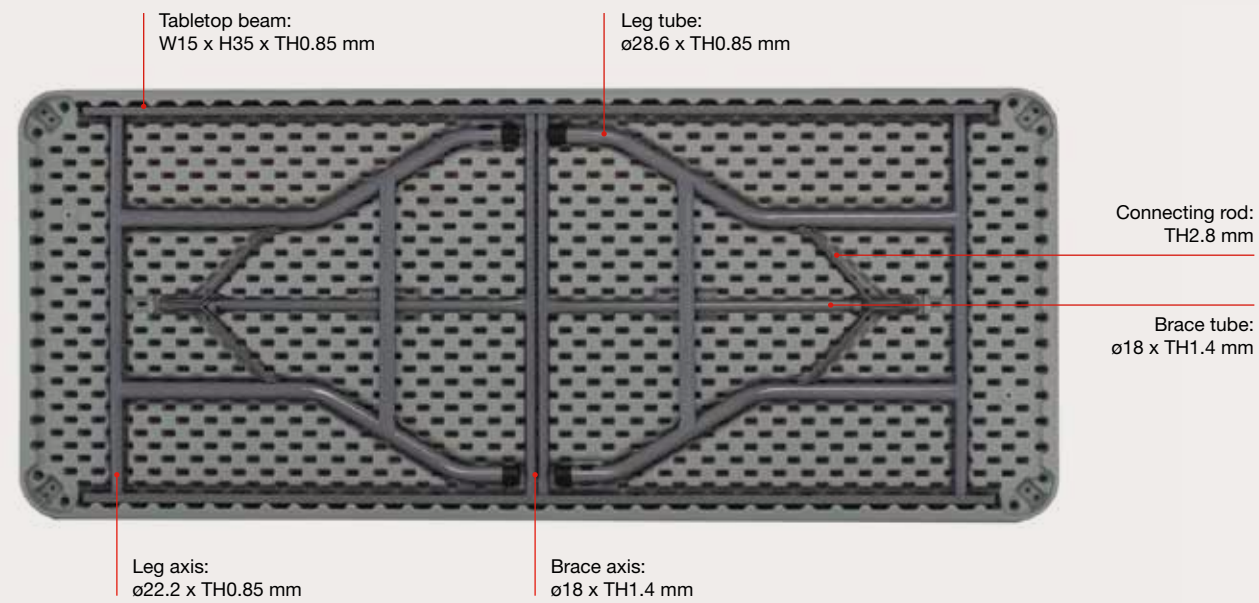
TABLE
MESA
TABLE
TISCH



H74.3 cm
H29.2"

45 mm

L182.9 x W76.2 cm
L6' x W29.6"



Tabletop beam:
W15 x H35 x TH0.85 mm

Leg tube:
ø28.6 x TH0.85 mm

Connecting rod:
TH2.8 mm

Brace tube:
ø18 x TH1.4 mm

Leg axis:
ø22.2 x TH0.85 mm

Brace axis:
ø18 x TH1.4 mm

stretch



table cover 0261 0876 0874 0873 0258 0875 0257
top cover 0508 0880 0878 0877 0505 0879 0504



paramount



table cover 0171 0884 0883 0174 0172 0176 0175
tablecloth 0556



232 x 126 cm
91.3" x 49.6"

plain



table cover 0404 0882 0881 0407 0405 0409 0408
tablecloth 0556



232 x 126 cm
91.3" x 49.6"



Sliding ring to lock the legs in position when in use. Easy and secure.

Argolla autodeslizante para bloquear las patas en posición de uso. Fácil y seguro.

Anneau autoglissant pour blocage des pieds en position d'usage. Facile et sûr.

Selbstgleitender Metallschiebering zur Feststellung der aufgeklappten Tischbeine. Einfach und sicher.

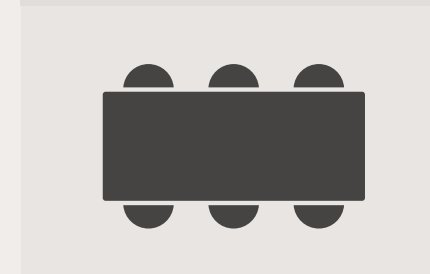


XLtrolley available for 20 tables. See page 52.

Carro XLtrolley disponible para 20 mesas. Ver pág. 52.

Chariot XLtrolley disponible pour 20 tables. Voir page 52.

Wagen XLtrolley lieferbar für 20 Tische. Siehe S. 52.

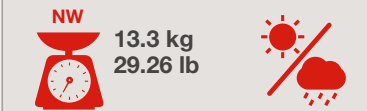


Capacity: 6 persons.
Area per person: 24".

Capacidad: 6 personas. Espacio por persona: 61 cm.

Capacité: 6 personnes.
Espace par personne: 61 cm.

Bietet Platz für 6 Personen. Platz pro Person: 61 cm.



| | |
|--------|---------------|
| Code | BT006X001T |
| Código | |
| Code | |
| Code | |
| EAN | 8436539296720 |
| Name | XL180vintage |
| Nombre | |
| Nom | |
| Name | |

Units per box 1
Unidades por caja
Unités par boîte
Stückzahl pro Packung

Packaging size 187.6 x 77.8 x 6.4 cm
Medidas embalaje 73.8" x 30.6" x 2.5"
Dimensions emballage
Verpackungsmaße

Packaging volume 0.092 m³
Volumen embalaje 3.248 ft³
Volume d'emballage
Verpackungsvolumen

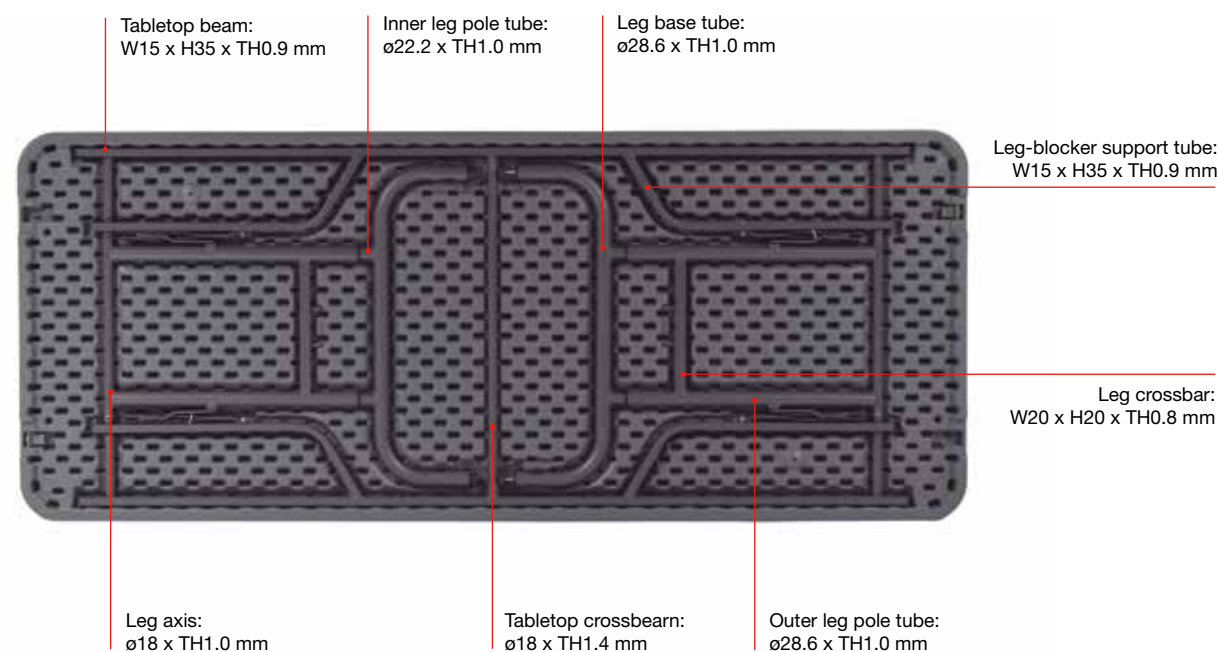
Gross weight 16.6 kg
Peso bruto 36.5 lb
Poids brut
Bruttogewicht

Loading quantity Container 40': 700
Unidades por contenedor Container 40' HC: 800
Unités par conteneur
Einheiten pro Container

SHARK
GREY

worktop180

new zown classic

100%
PURE HDPE.
NOT MIXED581-1
581-3 Contract
15372 L2H74.3 / 85.1 / 90.2 / 94.3 cm
H29.3" / 33.5" / 35.5" / 37.1"L182.9 x W75.2 cm
L6' x W29.6"

stretch



| | | | | | | | |
|-------------|------|------|------|------|------|------|------|
| table cover | 0261 | 0876 | 0874 | 0873 | 0258 | 0875 | 0257 |
| top cover | 0508 | 0880 | 0878 | 0877 | 0505 | 0879 | 0504 |



paramount



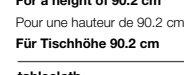
| | | | | | | | |
|-------------|------|------|------|------|------|------|------|
| table cover | 0171 | 0884 | 0883 | 0174 | 0172 | 0176 | 0175 |
| tablecloth | 0556 | | | | | | |



plain



| | | | | | | | |
|-----------------------------|-------|-------|-------|-------|-------|-------|-------|
| table cover | 0404 | 0882 | 0881 | 0407 | 0405 | 0409 | 0408 |
| Para altura 90.2 cm | 01496 | 01497 | 01498 | 01499 | 01500 | 01501 | 01502 |
| For a height of 90.2 cm | | | | | | | |
| Pour une hauteur de 90.2 cm | | | | | | | |
| Für Tischhöhe 90.2 cm | | | | | | | |
| tablecloth | 0556 | | | | | | |



Longitudinal table joining system.

Sistema de unión longitudinal.

Système d'assemblage longitudinal.

Längsverbindingssystem.

Practical mechanism for adjusting the table height.

Práctico mecanismo para ajustar la altura de la mesa.

Mécanisme pratique pour régler la hauteur de la table.

Praktische Vorrichtung zum Einstellen der Tischhöhe.

New and very smooth manual locking mechanism. Includes automatic sliding rings to prevent undesired folding.

Nuevo bloqueador manual de manejo muy suave. Incluye argollas autodeslizantes de seguridad para evitar el plegado involuntario.

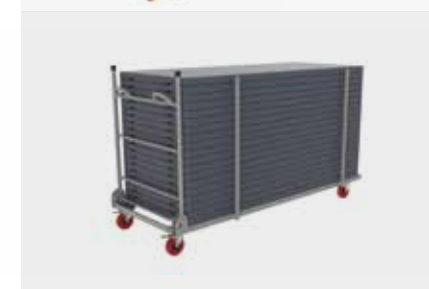
Nouveau mécanisme de blocage manuel au maniement très doux. Il inclut des anneaux autoglissant de sécurité pour éviter le pliage involontaire.

Neue, sehr leichtgängige, manuelle Verriegelung. Mit selbstgleitenden Sicherheitsringen, die ein unerwünschtes Zusammenklappen verhindern.

Height adjusters on 4 legs.

Regulador de altura en las 4 patas.

Régulateur de hauteur sur les 4 pieds.

Integrierte Höhenverstellung in den 4 Tischbeinen.XLtrolley available for 20 tables.
See page 52.**Carro XLtrolley disponible para 20 mesas. Ver pág. 52.**Chariot XLtrolley disponible pour 20 tables.
Voir page 52.**Wagen XLtrolley lieferbar für 20 Tische. Siehe S. 52.**

Ideal as a work surface.

Ideal como superficie de trabajo.

Idéal comme plan de travail.

Ideal als Arbeitsfläche.Multitrolley available for 14 tables.
See page 92.**Carro Multitrolley disponible para 14 mesas. Ver página 92.**Chariot Multitrolley disponible pour 14 tables.
Voir page 92.**Wagen Multitrolley lieferbar für 14 Tische. Siehe S. 92.**

270 kg
595 lb

24 hours
(*) p. 31

16.74 kg
36.90 lb

10 Limited 10 year warranty

| | |
|--------|---------------|
| Code | BT-06A-002-NC |
| Código | |
| Code | |
| Code | |

| | |
|-----|---------------|
| EAN | 8436539306627 |
|-----|---------------|

| | |
|--------|------------------|
| Name | worktop180 |
| Nombre | new zown classic |
| Nom | |
| Name | |

| | |
|-----------------------|---|
| Units per box | 1 |
| Unidades por caja | |
| Unités par boîte | |
| Stückzahl pro Packung | |

| | |
|----------------------|-----------------------|
| Packaging size | 185.4 x 77.8 x 6.4 cm |
| Medidas embalaje | 73" x 30.6" x 2.5" |
| Dimensions emballage | |
| Verpackungsmaße | |

| | |
|--------------------|----------------------|
| Packaging volume | 0.09 m ³ |
| Volumen embalaje | 3.24 ft ³ |
| Volume d'emballage | |
| Verpackungsvolumen | |

| | |
|---------------|----------|
| Gross weight | 18.47 kg |
| Peso bruto | 40.71 lb |
| Poids brut | |
| Bruttogewicht | |

| | |
|-------------------------|-----------------------|
| Loading quantity | Container 40': 700 |
| Unidades por contenedor | Container 40' HC: 800 |
| Unités par conteneur | |
| Einheiten pro Container | |

topshelf180

new zown classic

100%
PURE HDPE.
NOT MIXED

15372 L2

SHARK
GREY

| Code Código Code Code | EAN | Name Nombre Nom Name | Units per box Unidades por caja Unités par boîte Stückzahl pro Packung | Packaging size Medidas embalaje Dimensions emballage Verpackungsmaße | Packaging volume Volumen embalaje Volume d'emballage Verpackungsvolumen | Gross weight Peso bruto Poids brut Bruttogewicht | Loading quantity Unidades por contenedor Unités par conteneur Einheiten pro Container |
|--------------------------------|---------------|---------------------------------|---|---|--|---|--|
| PT-26-NC | 8436539306610 | topshelf180 new zown classic | 1 | 197 x 32 x 6 cm 77.5" x 12.75" x 2.4" | 0.03 m ³ 1.33 ft ³ | 7.90 kg 17.41 lb | Container 40': 1612 Container 40' HC: 1792 |



Upper shelf that can be attached to a Buffet table base, XXL180table, Sharp180table and the Worktop180 in order to turn the regular table into a buffet-table.

Estante superior para ser unido a las mesas Buffet table base, XXL180, Sharp180 y Worktop180 para convertirla en una mesa-buffet.

Tablette supplémentaire avec système d'accroche pour monter les tables Buffet table base, XXL180, Sharp180 et Worktop180 en buffet.

Tischaufsatz für Tisch Buffet table base, Verwandelt den XXL180, Sharp180 und Worktop180 Tischen in einen Büfettisch.

Ideal for displaying food in buffet services.

Ideal para la disposición de alimentos en servicios de buffet.

Idéal pour disposer différents plats lors d'un buffet.

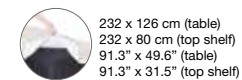
Ideal zum Anrichten von Speisen für Büfettis.

paramount



table cover 0105 0888 0887 0108 0106 0110 0109

top cover 0546



plain



table cover 0320 0886 0885 0323 0321 0325 0324

Sold as a complete set: Topshelf cover + XL180/Worktop180 table cover. **Se vende el conjunto completo: Funda para topshelf + Funda para mesa XL180/Worktop180.**
Les deux housses sont vendues ensemble : housse supérieure pour étagère + housse pour table XL180/Worktop180. **Verkauft wird das komplette Set: Husse für Topshelf + Husse für Tisch XL180/Worktop180.**



XL240

new zown classic

SHARK
GREY

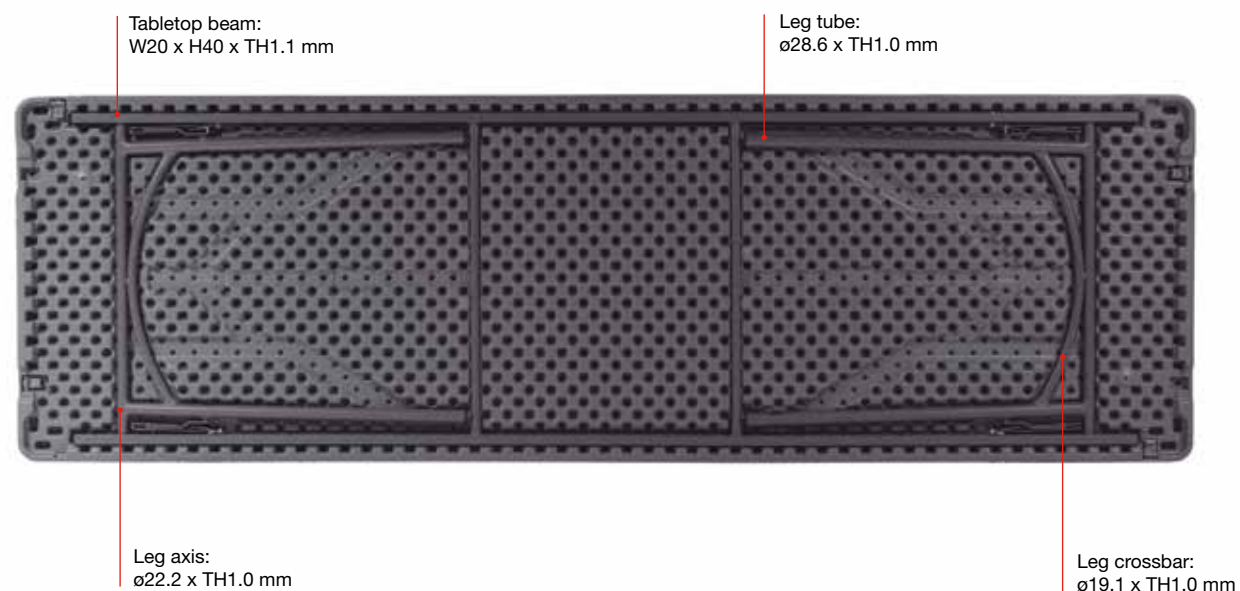
100%
PURE HDPE.
NOT MIXED



581-1
581-3 Contract
15372 L2



L243.8 x W76.2 cm
L8' x W30"



stretch

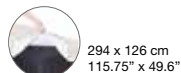


- table cover: 0268, 0892, 0890, 0889, 0265, 0891, 0264
- top cover: 0515, 0896, 0894, 0893, 0512, 0895, 0511

paramount



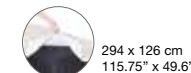
- table cover: 0177, 0900, 0899, 0180, 0178, 0182, 0181
- tablecloth: 0557



plain



- table cover: 0410, 0898, 0897, 0413, 0411, 0415, 0414
- tablecloth: 0557



Transverse and longitudinal table joining system.
Sistema de unión transversal y longitudinal.
Système d'assemblage transversal et longitudinal.
Querbindungssystem und Längsbindungssystem.



Ergonomic. Comfortable for those seated at the end of the table.
Ergonomía. Pleno confort también, para los usuarios ubicados en las cabeceras de la mesa.
Ergonomie. Confort total aussi pour les personnes situées en bout de table.
Ergonomie. Uneingeschränkter Sitzkomfort auch an der Kopfseite des Tisches.



New and very smooth manual locking mechanism. Includes automatic sliding rings to prevent undesired folding.

Nuevo bloqueador manual de manejo muy suave. Incluye argollas autodeslizantes de seguridad para evitar el plegado involuntario.

Nouveau mécanisme de blocage manuel au maniement très doux. Il inclut des anneaux autoglisants de sécurité pour éviter le pliage involontaire.

Neue, sehr leichtgängige, manuelle Verriegelung. Mit selbstgleitenden Sicherheitsringen, die ein unerwünschtes Zusammenklappen verhindern.

Integrated foot pads.

Tacos de las patas integrados.

Embouts des pieds intégrés.

In den Beinen integrierte Schutzkappen.

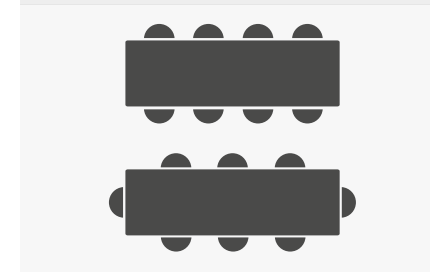


XLtrolley available for 18 tables.
See page 52.

Carro XLtrolley disponible para 18 mesas. Ver pág. 52.

Chariot XLtrolley disponible pour 18 tables.
Voir page 52.

Wagen XLtrolley lieferbar für 18 Tische. Siehe S. 52.



Capacity: 8 persons.
Area per person: 24".

Capacidad: 8 personas. Espacio por persona: 61 cm.

Capacité: 8 personnes.
Espace par personne: 61 cm.

Bietet Platz für 8 Personen. Platz pro Person: 61 cm.

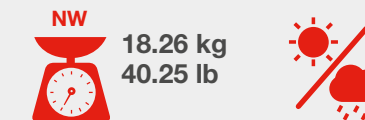


Multitrolley available for 14 tables.
See page 92.

Carro Multitrolley disponible para 14 mesas. Ver página 92.

Chariot Multitrolley disponible pour 14 tables.
Voir page 92.

Wagen Multitrolley lieferbar für 14 Tische. Siehe S. 92.



Code: BT008X010
Código: BT008X010
Code: BT008X010
Code: BT008X010

EAN: 8436539306474

Name: XL240
Nombre: new zown classic
Nom: new zown classic
Name: new zown classic

Units per box: 1
Unidades por caja: 1
Unités par boîte: 1
Stückzahl pro Packung: 1

Packaging size: 246 x 77.2 x 6.4 cm
Medidas embalaje: 96.9" x 30.4" x 2.5"
Dimensions emballage: 96.9" x 30.4" x 2.5"
Verpackungsmaße: 96.9" x 30.4" x 2.5"

Packaging volume: 0.12 m³
Volumen embalaje: 4.24 ft³
Volume d'emballage: 4.24 ft³
Verpackungsvolumen: 4.24 ft³

Gross weight: 21.84 kg
Peso bruto: 48.14 lb
Poids brut: 48.14 lb
Bruttogewicht: 48.14 lb

Loading quantity: Container 40': 384
Unidades por contenedor: Container 40' HC: 540
por contenedor: Container 40' HC: 540
Unités par conteneur: Container 40' HC: 540
Einheiten: Container 40' HC: 540
pro Container: Container 40' HC: 540

XLtrolley

100%
POWDER
COATED
STEEL

16121 L2

H115 cm
H45.3"L(193 + 61) x W77 cm
L(76" + 24") x W30.3"29.58 kg
65.22 lb

| Code Código Code Code | EAN | Name Nombre Nom Name | Units per box Unidades por caja Unités par boîte Stückzahl pro Packung | Packaging size Medidas embalaje Dimensions emballage Verpackungsmaße | Packaging volume Volumen embalaje Volume d'emballage Verpackungsvolumen | Gross weight Peso bruto Poids brut Bruttogewicht | Loading quantity Unidades por contenedor Unités par conteneur Einheiten pro Container |
|--------------------------------|---------------|-------------------------------|---|---|--|---|--|
| RA-102A | 8437009886038 | XLtrolley | 1 | 198.1 x 87 x 15.2 cm 78" x 34.2" x 6" | 0.26 m³ 9.25 ft³ | 35.35 kg 77.95 lb | Container 40": 229 Container 40" HC: 255 |



Part to hold the removable posts when folded. Bar with automatic unlocking mechanism which allows the vertical bracket to be folded. Trolley in fully folded position. Occupies a minimum of space. All parts are integrated to prevent loss.

Pieza para sujetar los postes extraíbles en posición de plegado. Barra con mecanismo automático para desbloquear y permitir el plegado del soporte vertical. Carro totalmente plegado. Ocupa mínimo espacio y todos sus componentes quedan integrados para no extraviarlos.

Pièce pour les poteaux extractibles en position de pliage. Barre avec mécanisme automatique pour blocage et déblocage et pour permettre le pliage du support vertical. Chariot entièrement plié. Occupe peu de place. Tous ses composants sont intégrés pour ne pas les perdre.

Halterungsvorrichtung für die herausnehmbaren Stangen in abgeklappter Position. Stange mit automatischem Mechanismus zum Entriegeln und Zusammenklappen des senkrechten Gestells. Der Wagen lässt sich vollständig zusammenklappen. Platzsparend sind alle Bestandteile integriert, damit sie nicht verloren gehen.



Peripheral posts to hold the stacked tables in place.

Postes périphériques pour immobiliser les tables empilées.

Poteaux périphériques pour immobilisation des tables empilées.

Sicherungsstangen verhindern das Verrutschen der gestapelten Tische.



Capacity: 28 pcs. XL120, 20 pcs. XL150, 20 pcs. XL180, 20 pcs. worktop180, 18 pcs. XL240.

Capacidad: 28u. XL120, 20u. XL150, 20u. XL180, 20 u. worktop180, 18u. XL240.

Capacité: 28u. XL120, 20u. XL150, 20u. XL180, 20 pcs. worktop180, 18u. XL240.

Fassungsvermögen: 28 Stk. XL120, 20 Stk. XL150, 20 Stk. XL180, 20 Stk. worktop180, 18 Stk. XL240.



Handle specially designed to protect the hands.

Asa especial para proteger las manos.

Anse spécialement conçue pour protéger les mains.

Ein spezieller Griff schützt die Hände.

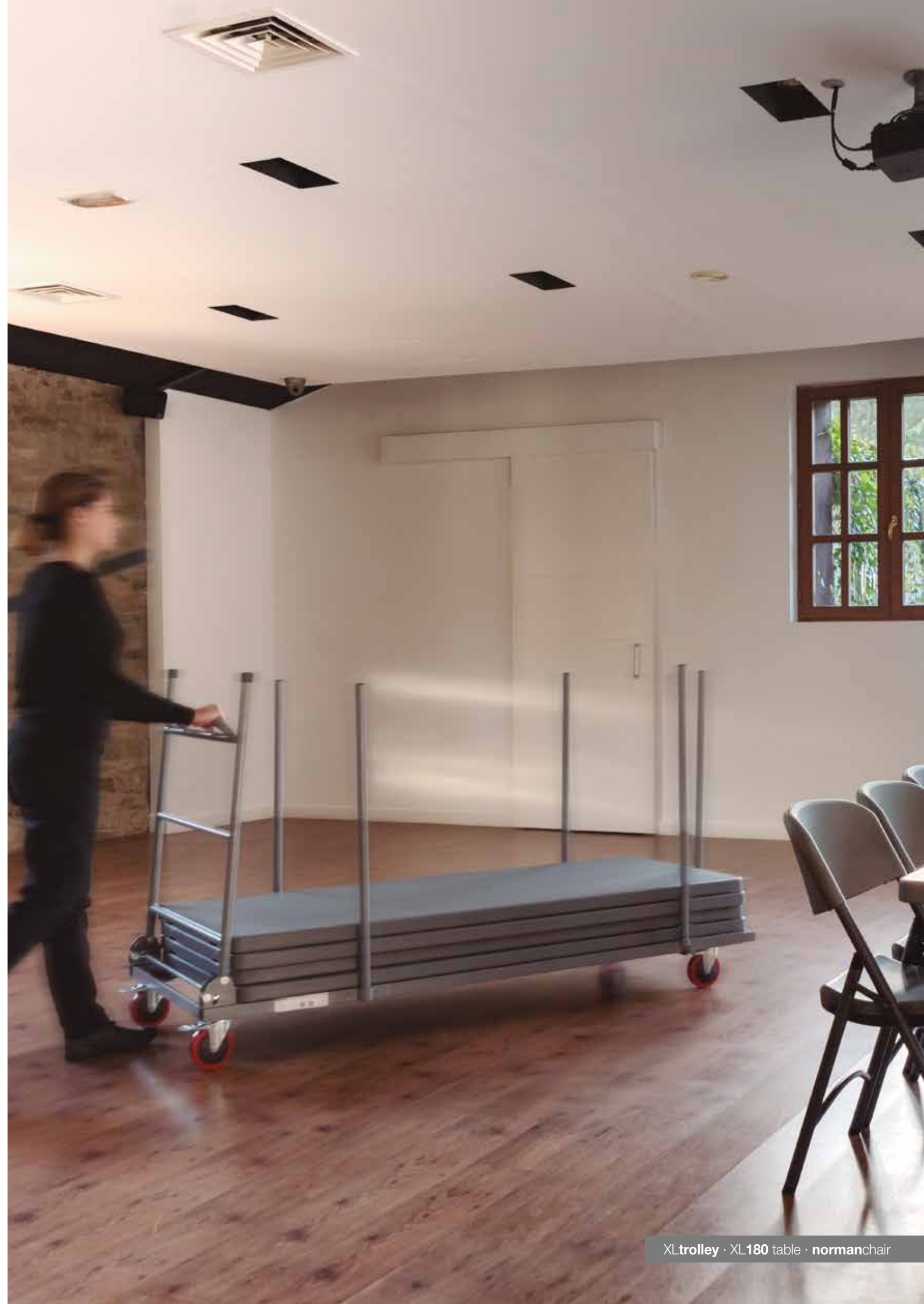


Four polyurethane wheels with built-in brake. (Two fixed wheels and two pivoting wheels).

4 ruedas de poliuretano con freno incorporado. (2 ruedas fijas y 2 ruedas pivotantes).

4 roues en polyuréthane avec frein intégré. (2 roues fixes et 2 roues pivotantes).

4 PU-Räder mit integrierter Bremse. (2 feststehende Räder und 2 Schwenkräder).



XLmoon

new zown classic

100%
PURE HDPE.
NOT MIXED

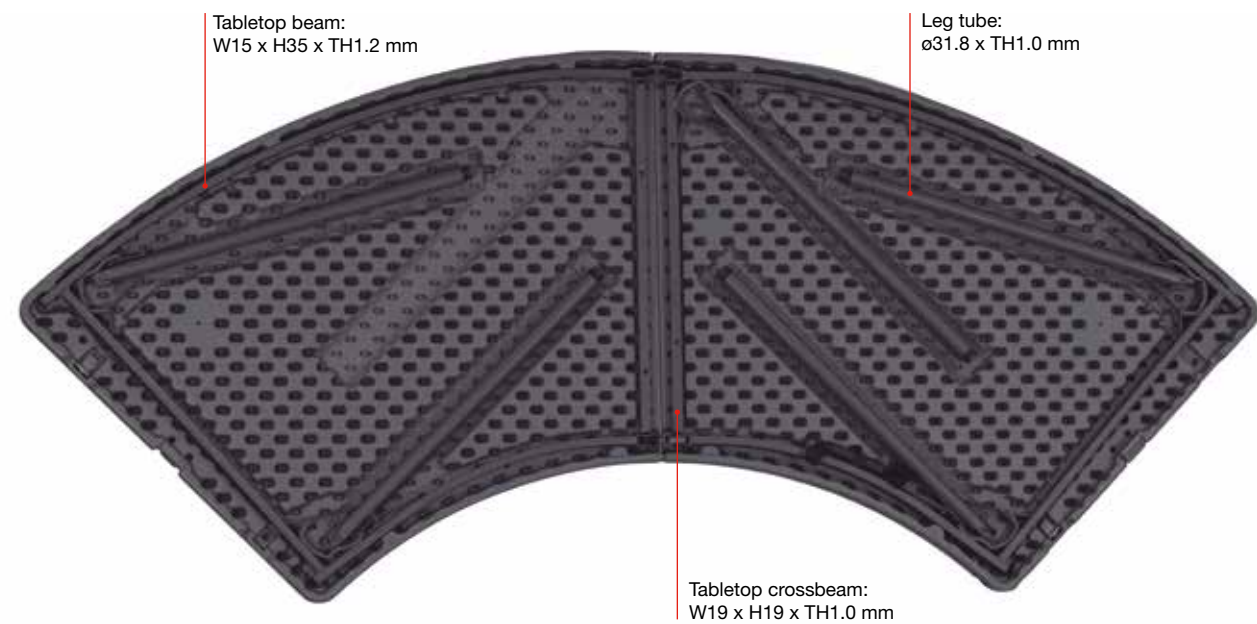


581-1
581-3 Contract
15372 L2

SHARK
GREY



L232.3 x W76.2 cm
L7.6' x W30"



stretch

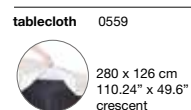


table cover 0903 0909 0907 0906 0904 0908 0905

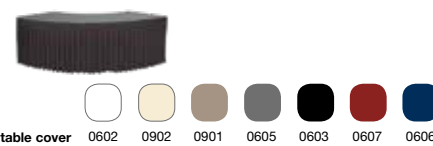
plain



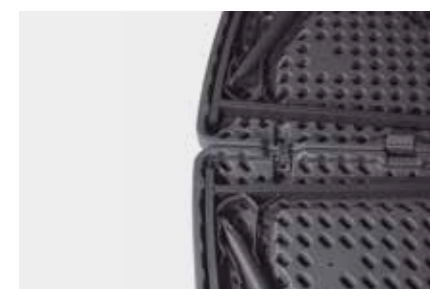
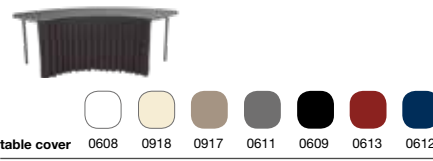
table cover 0910 0916 0915 0912 0911 0914 0913



paramount Ext. Arch XL moon



paramount Int. Arch XL moon



Circular table joining system.

Sistema de unión circular de mesas.

Système de raccord circulaire de tables.

Kreisförmigen Verbindung von Tischen.

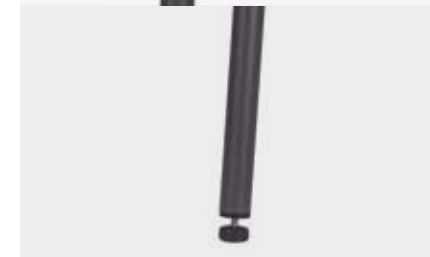


Automatic leg lock when in use.

Bloqueador automático de patas en posición de uso.

Blocage automatique des pieds en position d'usage.

Automatische Feststellung der aufgeklappten Tischbeine.



Height adjusters on 5 legs.

Regulador de altura en las 5 patas.

Régulateur de hauteur sur les 5 pieds.

Integrierte Höhenverstellung in den 5 Tischbeinen.

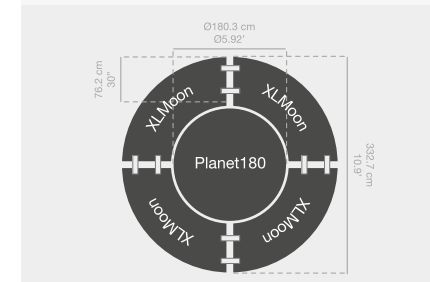


Folding table top. Table provided with carrying handle.

Sobre plegable. Mesa provista de un asa.

Surface pliable. Table munie d'une anse.

Der zusammengeklappte Tisch hat einen Tragegriff.



Circular joining of four XLmoon tables with 1 planet180 table.
Capacity for 12 to 16 persons.

**Unión circular de 4 mesas XLmoon con 1 mesa planet180.
Capacidad 12 a 16 personas.**

Raccord circulaire de 4 tables XLmoon avec 1 table planet180.
Capacité 12 à 16 personnes.

**Kreisförmige Verbindung von 4 Tischen XLmoon mit einem
Tisch planet180. Bietet Platz für 12 bis 16 Personen.**



Capacity: 3 or 4 persons.
Area per person: 34" or 25".

**Capacidad: 3 o 4 personas.
Espacio por persona: 87 o 65 cm.**

Capacité: 3 ou 4 personnes.
Espace par personne: 87 ou 65 cm.

**Bietet Platz für 3 oder 4 Personen.
Platz pro Person: 87 oder 65 cm.**

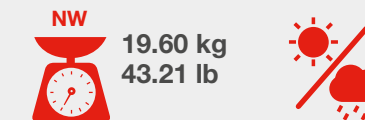


Multitrolley available for 6 tables.
See page 92.

**Carro Multitrolley disponible para 6 mesas.
Ver página 92.**

Chariot Multitrolley disponible pour 6 tables.
Voir page 92.

**Wagen Multitrolley lieferbar für 6 Tische.
Siehe S. 92.**



Code PT015X001
Código
Code
Code

EAN 8436539306504

Name XLmoon
Nombre new zown classic
Nom
Name

Units per box 1
Unidades por caja
Unités par boîte
Stückzahl pro Packung

Packaging size 128.2 x 83.1 x 11.4 cm
Medidas embalaje 50.5" x 32.7" x 4.5"
Dimensions emballage
Verpackungsmaße

Packaging volume 0.12 m³
Volumen embalaje 4.29 ft³
Volume d'emballage
Verpackungsvolumen

Gross weight 21.22 kg
Peso bruto 46.70 lb
Poids brut
Bruttogewicht

Loading quantity Container 40': 460
Unidades por contenedor Container 40' HC: 520
Unités par conteneur
Einheiten
pro Container



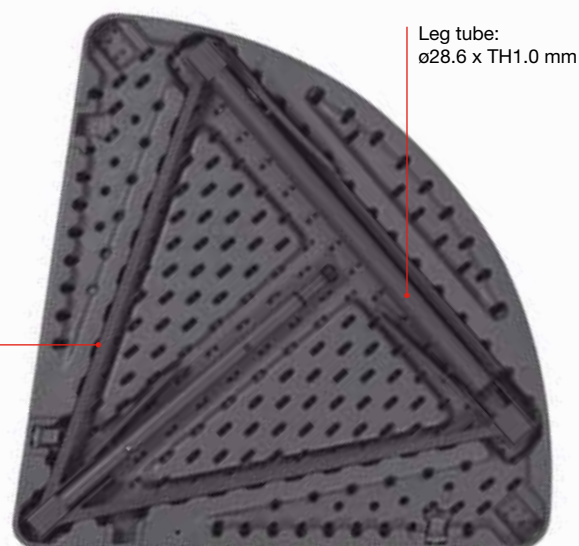
SHARK
GREY

XLcorner

new zown classic

100%
PURE HDPE.
NOT MIXED581-1
581-3 Contract
15372 L2H74.3 cm
H29.2"

45 mm

L75.1 x W75.1 cm
L29.5" x W29.5"Leg tube:
ø28.6 x TH1.0 mmTabletop beam:
W15 x H30 x TH1.0 mm

stretch

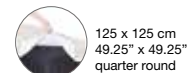


| | | | | | | | |
|-------------|------|------|------|------|------|------|------|
| table cover | 0921 | 0927 | 0925 | 0924 | 0922 | 0926 | 0923 |
|-------------|------|------|------|------|------|------|------|

plain



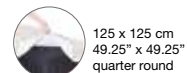
| | | | | | | | |
|-------------|------|------|------|------|------|------|------|
| table cover | 0928 | 0934 | 0933 | 0930 | 0929 | 0932 | 0931 |
| tablecloth | 0558 | | | | | | |

125 x 125 cm
49.25" x 49.25"
quarter round

paramount Ext. Arch XL corner



| | | | | | | | |
|-------------|------|------|------|------|------|------|------|
| table cover | 0596 | 0920 | 0919 | 0599 | 0597 | 0601 | 0600 |
| tablecloth | 0558 | | | | | | |

125 x 125 cm
49.25" x 49.25"
quarter roundSelf-adhesive velcro.
Velcro auto-adhesivo.
Auto-agrippant velcro.
Selbstklebendem klettband.

Angular table joining system.

Sistema de unión angular de mesas.

Système de raccord d'angle de tables.

Vorrichtung zur winkelförmigen Verbindung von Tischen.

Automatic leg lock when in use.

Bloquedor automático de patas en posición de uso.

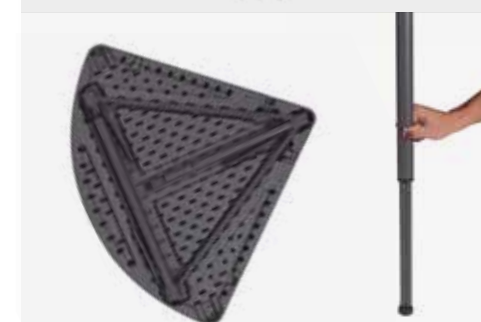
Blocage automatique des pieds en position d'usage.

Automatische Feststellung der aufgeklappten Tischbeine.

Height adjuster on 3 legs.

Regulador de altura incorporado en las 3 patas.

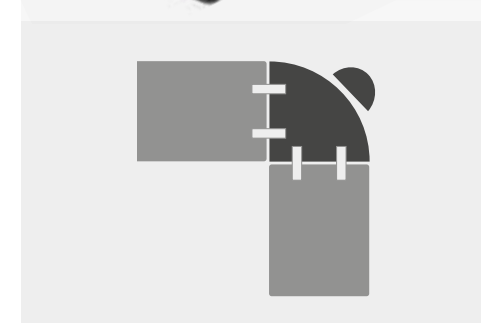
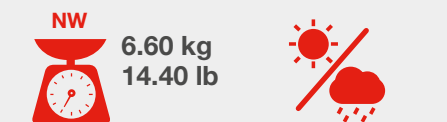
Régulateur de hauteur intégré aux 3 pieds.

Integrierte Höhenverstellung in den 3 Tischbeinen.

Telescopic leg for optimal folding.

Una pata telescópica para permitir un óptimo plegado.

Pied télescopique permettant un pliage optimal.

Ein zusammenschiebbares Tischbein ermöglicht ein optimales Zusammenklappen.Capacity: 1 person.
Area per person: 47".**Capacidad: 1 persona.
Espacio por persona: 119.4 cm.**Capacité: 1 personne.
Espace par personne: 119.4 cm.**Bietet Platz für 1 Person.
Platz pro Person: 119.4 cm.**Multitrolley available for 15 tables.
See page 92.**Carro Multitrolley disponible para 15 mesas.
Ver página 92.**Chariot Multitrolley disponible pour 15 tables.
Voir page 92.**Wagen Multitrolley lieferbar für 15 Tische.
Siehe S. 92.**Code
Código
Code
Code

PT-32-NC

EAN 8436539306634

Name
Nombre
Nom
Name

XLcorner

new zown classic

Units per box
Unidades por caja
Unités par boîte
Stückzahl pro Packung

2

Packaging size
Medidas embalaje
Dimensions emballage
Verpackungsmaße

78.1 x 76.8 x 14 cm

30.7" x 30.2" x 5.5"

Packaging volume
Volumen embalaje
Volume d'emballage
Verpackungsvolumen0.08 m³2.93 ft³Gross weight
Peso bruto
Poids brut
Bruttogewicht

14.40 kg

31.74 lb

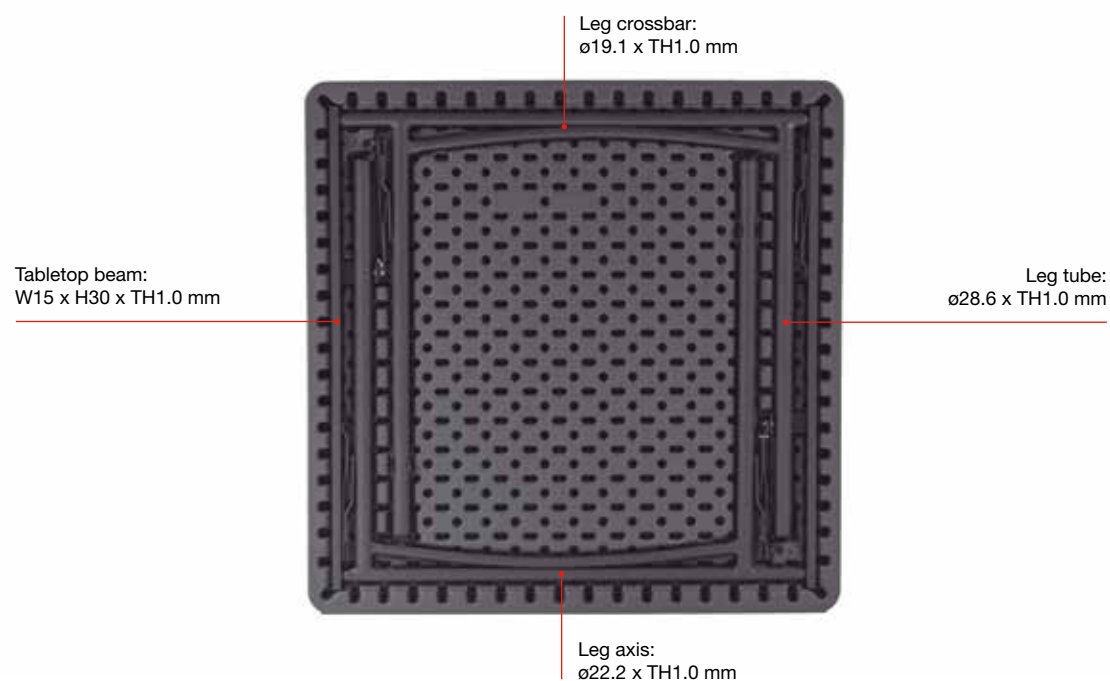
Loading quantity
Unidades
por contenedor
Unités par conteneur
Einheiten
pro Container

Container 40': 1456

Container 40' HC: 1640

XXL90

new zown classic

SHARK
GREY100%
PURE HDPE.
NOT MIXED581-1
581-3 Contract
15372 L2

stretch



table cover 0289 0938 0936 0935 0286 0937 0285

top cover 0536 0942 0940 0939 0533 0941 0532



paramount



table cover 0195 0946 0945 0198 0196 0200 0199

tablecloth 0562

142 x 142 cm
56" x 56"

plain



table cover 0428 0944 0943 0431 0429 0433 0432

tablecloth 0562

142 x 142 cm
56" x 56"

Ergonomic. Comfortable for those seated at the end of the table.

Ergonomía. Pleno confort también, para los usuarios ubicados en las cabeceras de la mesa.

Ergonomie. Confort total aussi pour les personnes situées en bout de table.

Ergonomie. Uneingeschränkter Sitzkomfort auch an der Kopfseite des Tisches.

New and very smooth manual locking mechanism. Includes automatic sliding rings to prevent undesired folding.

Nuevo bloqueador manual de manejo muy suave. Incluye argollas autodeslizantes de seguridad para evitar el plegado involuntario.

Nouveau mécanisme de blocage manuel au maniement très doux. Il inclut des anneaux autoglissant de sécurité pour éviter le pliage involontaire.

Neue, sehr leichtgängige, manuelle Verriegelung. Mit selbstgleitenden Sicherheitsringen, die ein unerwünschtes Zusammenklappen verhindern.

Integrated foot pads.

Tacos de las patas integrados.

Embouts des pieds intégrés.

In den Beinen integrierte Schutzkappen.

XXLtrolley available for 28 tables (2 stacks of 14 tables). See page 72.

Carro XXLtrolley disponible para 28 mesas (2 pilas de 14 mesas). Ver pág. 72.

Chariot XXLtrolley disponible pour 28 tables (2 piles de 14 tables). Voir page 72.

Wagen XXLtrolley lieferbar für 28 Tische (2 Stapel mit jeweils 14 Tischen). Siehe S. 72.

Capacity: 4 persons.
Area per person: 24".

**Capacidad: 4 personas.
Espacio por persona: 61 cm.**

Capacité: 4 personnes.
Espace par personne: 61 cm.

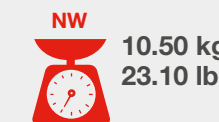
**Bietet Platz für 4 Personen.
Platz pro Person: 61 cm.**

Multitrolley available for 15 tables. See page 92.

Carro Multitrolley disponible para 15 mesas. Ver página 92.

Chariot Multitrolley disponible pour 15 tables. Voir page 92.

Wagen Multitrolley lieferbar für 15 Tische. Siehe S. 92.



10 Limited 10 year warranty

Code BT-36-NC
Código
Code
Code

EAN 8436539306641

Name **XXL90**
Nombre new zown classic
Nom
Name

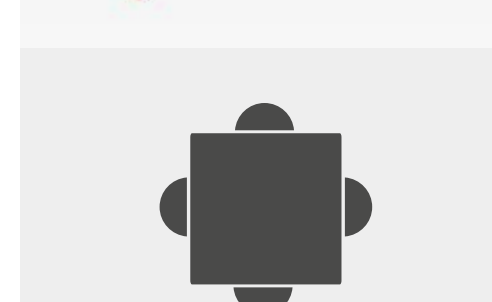
Units per box 1
Unidades por caja
Unités par boîte
Stückzahl pro Packung

Packaging size 93.4 x 94 x 6.4 cm
Medidas embalaje 36.7" x 37" x 2.5"
Dimensions emballage
Verpackungsmaße

Packaging volume 0.05 m³
Volumen embalaje 1.97 ft³
Volume d'emballage
Verpackungsvolumen

Gross weight 11.64 kg
Peso bruto 25.66 lb
Poids brut
Bruttogewicht

Loading quantity Container 40': 1076
Unidades por contenedor Container 40' HC: 1204
Unités par conteneur
Einheiten
pro Container

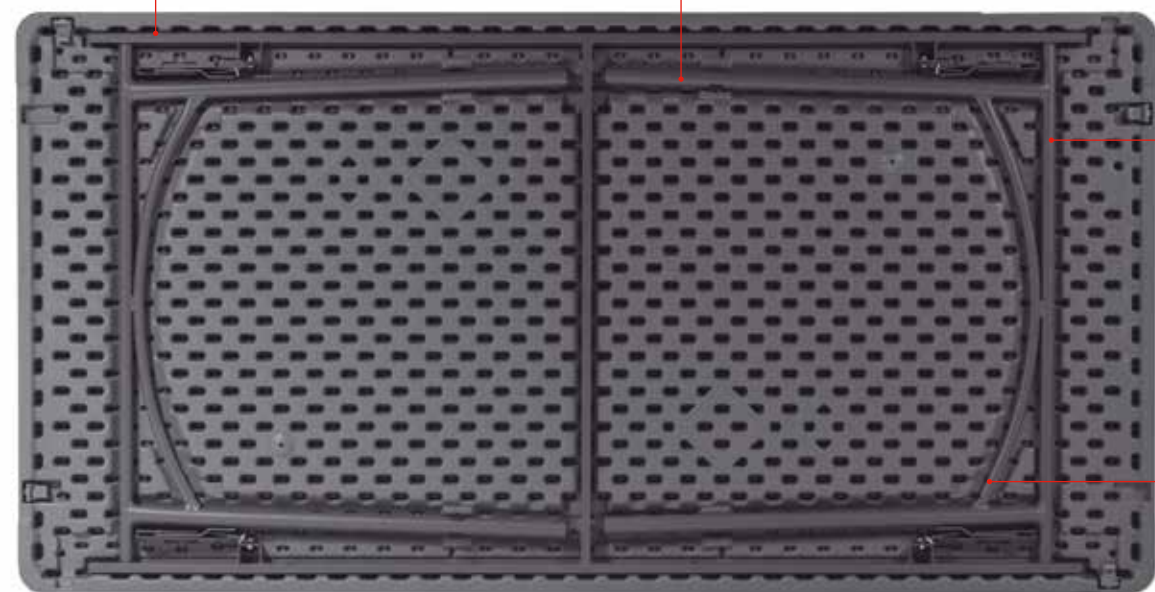


XXL180

new zown classic

SHARK
GREY100%
PURE HDPE.
NOT MIXED581-1
581-3 Contract
15372 L2H74.3 cm
H29.3"

45 mm

L182.9 x W91.4 cm
L6' x W36"Tabletop beam:
W15 x H35 x TH1.2 mmLeg tube:
ø28.6 x TH1.0 mmLeg axis:
ø22.2 x TH1.2 mmLeg crossbar:
ø19.1 x TH1.0 mm

stretch



table cover 01393 01394 01395 01396 01397 01398 01399

top cover 01400 01401 01402 01403 01404 01405 01406

paramount



table cover 01414 01415 01416 01417 01418 01419 01420

tablecloth 01421

233 x 142 cm
91.7" x 55.9"

plain



table cover 01407 01408 01409 01410 01411 01412 01413

tablecloth 01421

233 x 142 cm
91.7" x 55.9"

Transverse and longitudinal table joining system.

Sistema de unión transversal y longitudinal.

Système d'assemblage transversal et longitudinal.

Querbindungssystem und Längsbindungssystem.

Ergonomic. Comfortable for those seated at the end of the table.

Ergonomía. Pleno confort también, para los usuarios ubicados en las cabeceras de la mesa.

Ergonomie. Confort total aussi pour les personnes situées en bout de table.

Ergonomie. Uneingeschränkter Sitzkomfort auch an der Kopfseite des Tisches.

New and very smooth manual locking mechanism. Includes automatic sliding rings to prevent undesired folding.

Nuevo bloqueador manual de manejo muy suave. Incluye argollas autodeslizantes de seguridad para evitar el plegado involuntario.

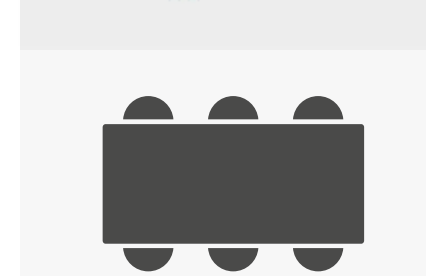
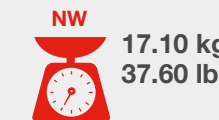
Nouveau mécanisme de blocage manuel au maniement très doux. Il inclut des anneaux autoglissant de sécurité pour éviter le pliage involontaire.

Neue, sehr leichtgängige, manuelle Verriegelung. Mit selbstgleitenden Sicherheitsringen, die ein unerwünschtes Zusammenklappen verhindern.

Integrated foot pads.

Tacos de las patas integrados.

Embouts des pieds intégrés.

In den Beinen integrierte Schutzkappen.XXLtrolley available for 18 tables.
See page 72.**Carro XXLtrolley disponible para 18 mesas. Ver pág. 72.**Chariot XXLtrolley disponible pour 18 tables.
Voir page 72.**Wagen XLtrolley lieferbar für 18 Tische. Siehe S. 72.**Capacity: 6 persons.
Area per person: 24".**Capacidad: 6 personas. Espacio por persona: 61 cm.**Capacité: 6 personnes.
Espace par personne: 61 cm.**Bietet Platz für 6 Personen. Platz pro Person: 61 cm.**Multitrolley available for 15 tables.
See page 92.**Carro Multitrolley disponible para 15 mesas. Ver página 92.**Chariot Multitrolley disponible pour 15 tables.
Voir page 92.**Wagen Multitrolley lieferbar für 15 Tische. Siehe S. 92.**Code
Código
Code
Code

PT050X001

EAN 8436539306658

Name
Nombre
Nom
NameXXL180
new zown classicUnits per box 1
Unidades por caja
Unités par boîte
Stückzahl pro PackungPackaging size 185.4 x 93.4 x 6.4 cm
Medidas embalaje 73" x 36.8" x 2.5"
Dimensions emballage
VerpackungsmaßePackaging volume 0.11 m³
Volumen embalaje 3.88 ft³
Volume d'emballage
VerpackungsvolumenGross weight 19.98 kg
Peso bruto 44.04 lb
Poids brut
BruttogewichtLoading quantity Container 40': 586
Unidades por contenedor Container 40' HC: 646
por contenedor
Unités par conteneur
Einheiten
pro Container

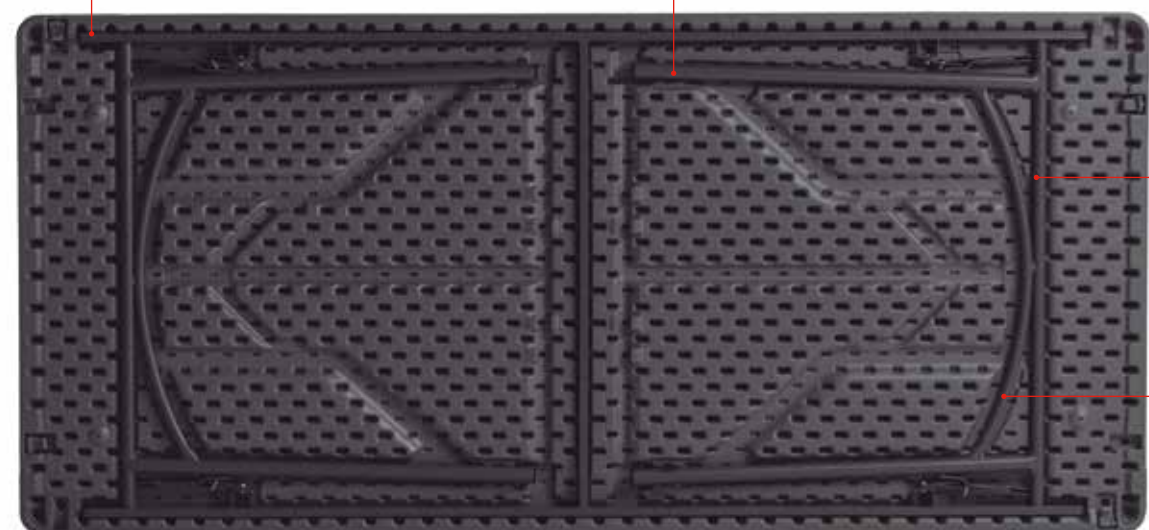


XXL200

new zown classic

SHARK
GREY100%
PURE HDPE.
NOT MIXED581-1
581-3 Contract
15372 L2H74.3 cm
H29.3"

45 mm

L198.2 x W91.4 cm
L6.5' x W36"Tabletop beam:
W15 x H35 x TH1.5 mmLeg tube:
ø28.6 x TH1.0 mmLeg axis:
ø22.2 x TH1.2 mmLeg crossbar:
ø19.1 x TH1.0 mm

stretch



| | | | | | | | |
|-------------|------|------|------|------|------|------|------|
| table cover | 0275 | 0950 | 0948 | 0947 | 0272 | 0949 | 0271 |
| top cover | 0522 | 0954 | 0952 | 0951 | 0519 | 0953 | 0518 |



paramount



| | | | | | | | |
|-------------|------|------|------|------|------|------|------|
| table cover | 0183 | 0958 | 0957 | 0186 | 0184 | 0188 | 0187 |
| tablecloth | 0560 | | | | | | |

248 x 142 cm
94.64" x 56"

plain



| | | | | | | | |
|-------------|------|------|------|------|------|------|------|
| table cover | 0416 | 0956 | 0955 | 0419 | 0417 | 0421 | 0420 |
| tablecloth | 0560 | | | | | | |

248 x 142 cm
94.64" x 56"

Transverse and longitudinal table joining system.

Sistema de unión transversal y longitudinal.

Système d'assemblage transversal et longitudinal.

Querbindungssystem und Längsbindungssystem.

Ergonomic. Comfortable for those seated at the end of the table.

Ergonomía. Pleno confort también, para los usuarios ubicados en las cabeceras de la mesa.

Ergonomie. Confort total aussi pour les personnes situées en bout de table.

Ergonomie. Uneingeschränkter Sitzkomfort auch an der Kopfseite des Tisches.

New and very smooth manual locking mechanism. Includes automatic sliding rings to prevent undesired folding.

Nuevo bloqueador manual de manejo muy suave. Incluye argollas autodeslizantes de seguridad para evitar el plegado involuntario.

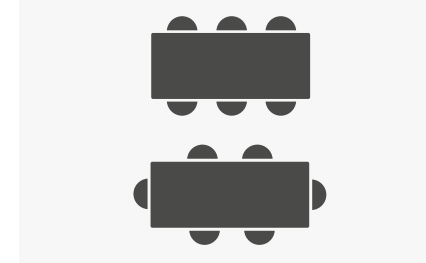
Nouveau mécanisme de blocage manuel au maniement très doux. Il inclut des anneaux autoglissant de sécurité pour éviter le pliage involontaire.

Neue, sehr leichtgängige, manuelle Verriegelung. Mit selbstgleitenden Sicherheitsringen, die ein unerwünschtes Zusammenklappen verhindern.

Integrated foot pads.

Tacos de las patas integrados.

Embouts des pieds intégrés.

In den Beinen integrierte Schutzkappen.XXLtrolley available for 18 tables.
See page 72.**Carro XXLtrolley disponible para 18 mesas. Ver pág. 72.**Chariot XXLtrolley disponible pour 18 tables.
Voir page 72.**Wagen XLtrolley lieferbar für 18 Tische. Siehe S. 72.**Capacity: 6 persons.
Area per person: 26" / 27".**Capacidad: 6 personas. Espacio por persona: 66 cm. / 69 cm.**Capacité: 6 personnes.
Espace par personne: 66 cm. / 69 cm.**Bietet Platz für 6 Personen. Platz pro Person: 66 cm. / 69 cm.**Multitrolley available for 15 tables.
See page 92.**Carro Multitrolley disponible para 15 mesas. Ver página 92.**Chariot Multitrolley disponible pour 15 tables.
Voir page 92.**Wagen Multitrolley lieferbar für 15 Tische. Siehe S. 92.**

6

453 kg
1000 lb
24 hours
(*) p. 3117.95 kg
39.57 lb

Limited 10 year warranty

Code PT024X002
Código
Code
Code

EAN 8436539306481

Name XXL200
Nombre new zown classic
Nom
NameUnits per box 1
Unidades por caja
Unités par boîte
Stückzahl pro PackungPackaging size 200.66 x 93.7 x 6.35 cm
Medidas embalaje 79" x 36.9" x 2.5"
Dimensions emballage
VerpackungsmaßePackaging volume 0.11 m³
Volumen embalaje 3.88 ft³
Volume d'emballage
VerpackungsvolumenGross weight 21.06 kg
Peso bruto 46.42 lb
Poids brut
BruttogewichtLoading quantity Container 40': 516
Unidades por contenedor Container 40' HC: 576
por contenedor
Unités par conteneur
Einheiten
pro Container



XXL240

new zown classic

SHARK
GREY100%
PURE HDPE.
NOT MIXED581-1
581-3 Contract
15372 L2L240 x W91.4 cm
L8' x W36"Tabletop beam:
W20 x H40 x TH1.4 mmLeg tube:
ø28.6 x TH1.0 mmLeg axis:
ø22.2 x TH1.2 mmLeg crossbar:
ø19.1 x TH1.0 mm

stretch



| | | | | | | | |
|-------------|------|------|------|------|------|------|------|
| table cover | 0282 | 0962 | 0960 | 0959 | 0279 | 0961 | 0278 |
| top cover | 0529 | 0906 | 0964 | 0963 | 0526 | 0965 | 0525 |



paramount



| | | | | | | | |
|-------------|------|------|------|------|------|------|------|
| table cover | 0189 | 0970 | 0969 | 0192 | 0190 | 0194 | 0193 |
| tablecloth | 0561 | | | | | | |

290 x 142 cm
114.18" x 56"

plain



| | | | | | | | |
|-------------|------|------|------|------|------|------|------|
| table cover | 0422 | 0968 | 0967 | 0425 | 0423 | 0427 | 0426 |
| tablecloth | 0561 | | | | | | |

290 x 142 cm
114.18" x 56"

Transverse and longitudinal table joining system.

Sistema de unión transversal y longitudinal.

Système d'assemblage transversal et longitudinal.

Querbindungssystem und Längsbindungssystem.

Ergonomic. Comfortable for those seated at the end of the table.

Ergonomía. Pleno confort también, para los usuarios ubicados en las cabeceras de la mesa.

Ergonomie. Confort total aussi pour les personnes situées en bout de table.

Ergonomie. Uneingeschränkter Sitzkomfort auch an der Kopfseite des Tisches.

New and very smooth manual locking mechanism. Includes automatic sliding rings to prevent undesired folding.

Nuevo bloqueador manual de manejo muy suave. Incluye argollas autodeslizantes de seguridad para evitar el plegado involuntario.

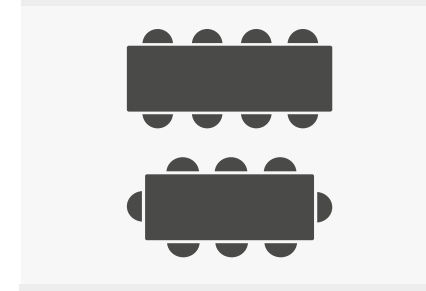
Nouveau mécanisme de blocage manuel au maniement très doux. Il inclut des anneaux autoglissant de sécurité pour éviter le pliage involontaire.

Neue, sehr leichtgängige, manuelle Verriegelung. Mit selbstgleitenden Sicherheitsringen, die ein unerwünschtes Zusammenklappen verhindern.

Integrated foot pads.

Tacos de las patas integrados.

Embouts des pieds intégrés.

In den Beinen integrierte Schutzkappen.XXLtrolley available for 15 tables.
See page 72.**Carro XXLtrolley disponible para 15 mesas. Ver pág. 72.**Chariot XXLtrolley disponible pour 15 tables.
Voir page 72.**Wagen XLtrolley lieferbar für 15 Tische. Siehe S. 72.**Capacity: 8 persons.
Area per person: 24".**Capacidad: 8 personas. Espacio por persona: 61 cm.**Capacité: 8 personnes.
Espace par personne: 61 cm.**Bietet Platz für 8 Personen. Platz pro Person: 61 cm.**Multitrolley available for 13 tables.
See page 92.**Carro Multitrolley disponible para 13 mesas. Ver página 92.**Chariot Multitrolley disponible pour 13 tables.
Voir page 92.**Wagen Multitrolley lieferbar für 13 Tische. Siehe S. 92.**

8

453 kg
1000 lb
24 hours
(*) p. 3125.60 kg
56.43 lb

Limited 10 year warranty

Code
Código
Code
Code
PT012X004EAN
8436539306498Name
Nombre
Nom
Name
XXL240
new zown classicUnits per box
Unidades por caja
Unités par boîte
Stückzahl pro Packung
1Packaging size
Medidas embalaje
Dimensions emballage
Verpackungsmaße
242.6 x 93.7 x 7 cm
95.5" x 36.9" x 2.8"Packaging volume
Volumen embalaje
Volume d'emballage
Verpackungsvolumen
0.16 m³
5.65 ft³Gross weight
Peso bruto
Poids brut
Bruttogewicht
28.33 kg
62.45 lbLoading quantity
Unidades
por contenedor
Unités par conteneur
Einheiten
pro Container
Container 40': 370
Container 40' HC: 440

XXL trolley

100%
POWDER
COATED
STEEL



16121 L2

H115 cm
H45.3"



L(202 + 46) x W92 cm
L(79.6" + 18.1") x W36.2"



31.40 kg
69.20 lb

| Code Código Code Code | EAN | Name Nombre Nom Name | Units per box Unidades por caja Unités par boîte Stückzahl pro Packung | Packaging size Medidas embalaje Dimensions emballage Verpackungsmaße | Packaging volume Volumen embalaje Volume d'emballage Verpackungsvolumen | Gross weight Peso bruto Poids brut Bruttogewicht | Loading quantity Unidades por contenedor Unités par conteneur Einheiten pro Container |
|--------------------------------|---------------|-------------------------------|---|---|--|---|--|
| RA-105A | 8437009886069 | XXL trolley | 1 | 212.7 x 101.6 x 15.2 cm 83.7" x 40" x 6" | 0.32 m ³ 11.58 ft ³ | 37.10 kg 81.60 lb | Container 40': 189 Container 40' HC: 210 |



Part to hold the removable posts when folded. Bar with automatic unlocking mechanism which allows the vertical bracket to be folded. Trolley in fully folded position. Occupies a minimum of space. All parts are integrated to prevent loss.

Pieza para sujetar los postes extraíbles en posición de plegado. Barra con mecanismo automático para desbloquear y permitir el plegado del soporte vertical. Carro totalmente plegado. Ocupa mínimo espacio y todos sus componentes quedan integrados para no extraviarlos.

Pièce pour les poteaux extractibles en position de pliage. Barre avec mécanisme automatique pour blocage et déblocage et pour permettre le pliage du support vertical. Chariot entièrement plié. Occupe peu de place. Tous ses composants sont intégrés pour ne pas les perdre.

Haltevorrichtung für die herausnehmbaren Stangen in abgeklappter Position. Stange mit automatischem Mechanismus zum Entriegeln und Zusammenklappen des senkrechten Gestells. Der Wagen lässt sich vollständig zusammenklappen. Platzsparend sind alle Bestandteile integriert, damit sie nicht verloren gehen.



Peripheral posts to hold the stacked tables in place.

Postes périphériques pour immobiliser les tables empilées.

Poteaux périphériques pour immobilisation des tables empilées.

Sicherungsstangen verhindern das Verrutschen der gestapelten Tische.



Handle specially designed to protect the hands.

Asa especial para proteger las manos.

Anse spécialement conçue pour protéger les mains.

Ein spezieller Griff schützt die Hände.



Capacity: 28 pcs. XXL90, 18 pcs. XXL180, 18 pcs. XXL200, 15 pcs. XXL240, 24 pcs. M183.

Capacidad: 28u. XXL90, 18u. XXL180, 18u. XXL200, 15 u. XXL240, 24u. M183.

Capacité: 28u. XXL90, 18u. XXL180, 18u. XXL200, 15 u. XXL240, 24u. M183.

Fassungsvermögen: 28 Stk. XXL90, 18 Stk. XXL180, 18 Stk. XXL200, 15 Stk. XXL240, 24 Stk. M183.



Four polyurethane wheels with built-in brake. (Two fixed wheels and two pivoting wheels).

4 ruedas de poliuretano con freno incorporado. (2 ruedas fijas y 2 ruedas pivotantes).

4 roues en polyuréthane avec frein intégré. (2 roues fixes et 2 roues pivotantes).

4 PU-Räder mit integrierter Bremse. (2 feststehende Räder und 2 Schwenkräder).



XXLmoon

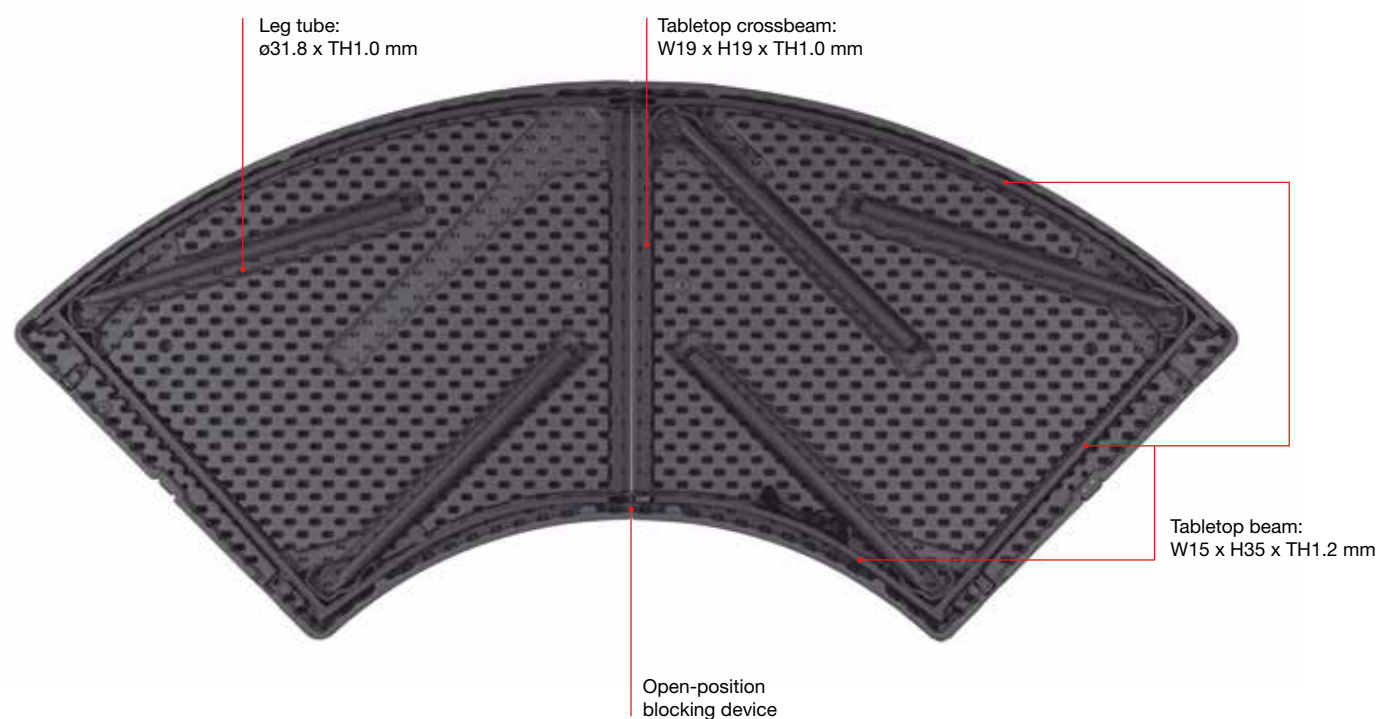
new zown classic

100%
PURE HDPE.
NOT MIXED



581-1
581-3 Contract
15372 L2

SHARK
GREY



stretch



table cover 0991 0997 0995 0994 0992 0996 0993

plain



table cover 0998 1004 1003 1000 0999 1002 1001

tablecloth 0646



300 x 141 cm
118.12" x 55.5"
crescent

paramount Ext. Arch XXL moon

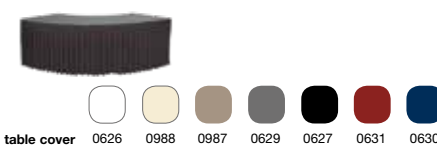


table cover 0626 0988 0987 0629 0627 0631 0630

paramount Int. Arch XXL moon

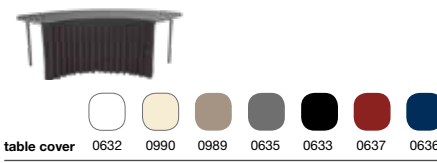


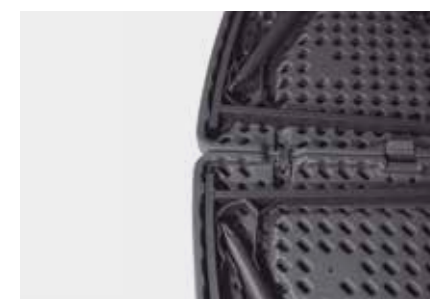
table cover 0632 0990 0989 0635 0633 0637 0636

tablecloth 0646



300 x 141 cm
118.12" x 55.5"
crescent

Self-adhesive velcro.
Velcro auto-adhesivo.
Auto-agrippant velcro.
Selbstklebendem Klettband.



Circular table joining system.

Sistema de unión circular de mesas.

Système de raccord circulaire de tables.

Kreisförmigen Verbindung von Tischen.



Automatic leg lock when in use.

Bloqueador automático de patas en posición de uso.

Blocage automatique des pieds en position d'usage.

Automatische Feststellung der aufgeklappten Tischbeine.



Height adjusters on 5 legs.

Regulador de altura en las 5 patas.

Régulateur de hauteur sur les 5 pieds.

Integrierte Höhenverstellung in den 5 Tischbeinen.

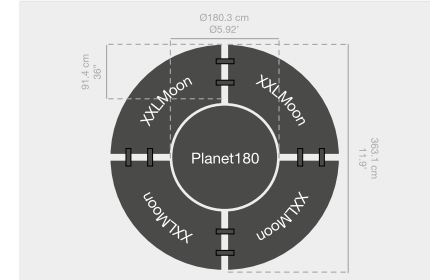


Folding table top. Table provided with carrying handle.

Sobre plegable. Mesa provista de un asa.

Surface pliable. Table munie d'une anse.

Der zusammengeklappte Tisch hat einen Tragegriff.



Circular joining of four XXLmoon tables with 1 planet180 table. Capacity for 16 to 20 persons.

Unión circular de 4 mesas XXLmoon con 1 mesa planet180. Capacidad 16 a 20 personas.

Raccord circulaire de 4 tables XXLmoon avec 1 table planet180. Capacité 16 à 20 personnes.

Kreisförmige Verbindung von 4 Tischen XXLmoon mit einem Tisch planet180. Bietet Platz für 16 bis 20 Personen.



Capacity: 4 or 5 persons.

Area per person: 28" or 22.5".

Capacidad: 4 o 5 personas. Espacio por persona: 71 o 57 cm.

Capacité: 4 ou 5 personnes. Espace par personne: 71 ou 57 cm.

Bietet Platz für 4 oder 5 Personen. Platz pro Person: 71 oder 57 cm.

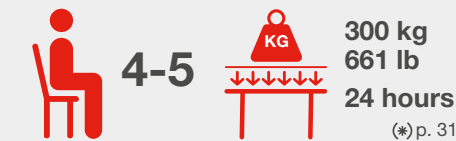


Multitrolley available for 6 tables. See page 92.

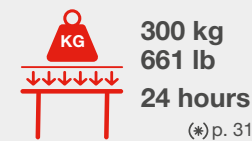
Carro Multitrolley disponible para 6 mesas. Ver página 92.

Chariot Multitrolley disponible pour 6 tables. Voir page 92.

Wagen Multitrolley lieferbar für 6 Tische. Siehe S. 92.



4-5



300 kg

661 lb

24 hours

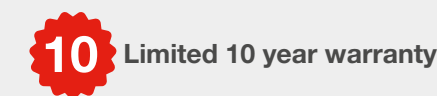
(*)p. 31



NW

22 kg

48.50 lb



Limited 10 year warranty

Code PT016X002
Código
Code
Code

EAN 8436539306511

Name XXLmoon
Nombre new zown classic
Nom
Name

Units per box 1
Unidades por caja
Unités par boîte
Stückzahl pro Packung

Packaging size 142.2 x 101 x 12 cm
Medidas embalaje 56" x 39.7" x 4.7"
Dimensions emballage
Verpackungsmaße

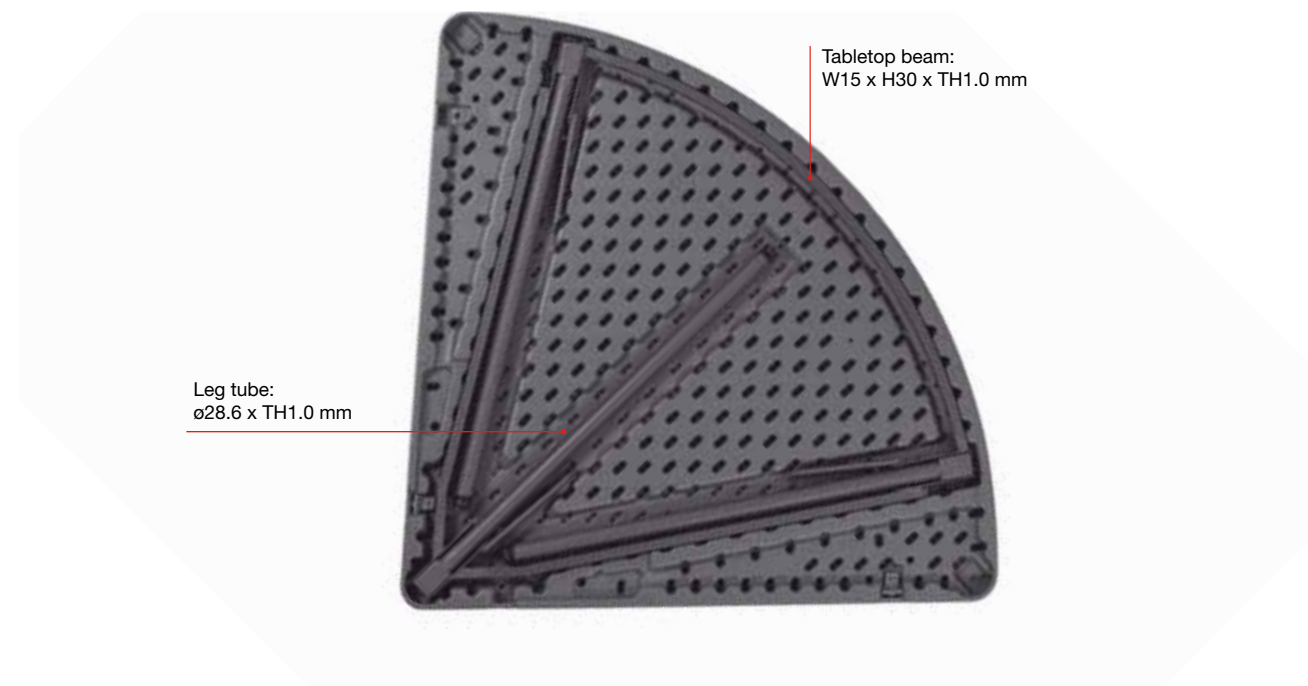
Packaging volume 0.17 m³
Volumen embalaje 6.07 ft³
Volume d'emballage
Verpackungsvolumen

Gross weight 25 kg
Peso bruto 55.11 lb
Poids brut
Bruttogewicht

Loading quantity Container 40': 344
Unidades por contenedor Container 40' HC: 390
Unités par conteneur
Einheiten
pro Container

XXLcorner

new zown classic

SHARK
GREY100%
PURE HDPE.
NOT MIXED581-1
581-3 Contract
15372 L2

stretch



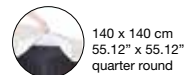
table cover 0973 0979 0977 0976 0974 0978 0975

plain



table cover 0980 0986 0985 0982 0981 0984 0983

tablecloth 0645

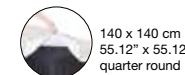


paramount Ext. Arch XXL corner



table cover 0620 0972 0971 0623 0621 0625 0624

tablecloth 0645



Self-adhesive velcro.
Velcro auto-adhesivo.
Auto-agrippant velcro.
Selbstklebendem Klettband.



Angular table joining system.

Sistema de unión angular de mesas.

Système de raccord d'angle de tables.

Vorrichtung zur winkelförmigen Verbindung von Tischen.

Automatic leg lock when in use.

Bloquedor automático de patas en posición de uso.

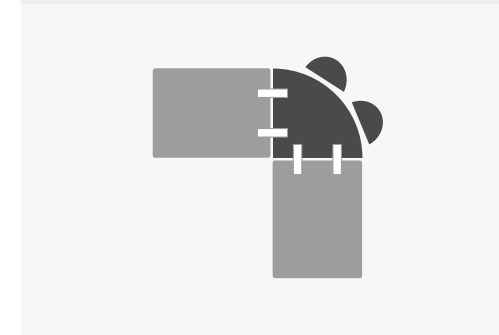
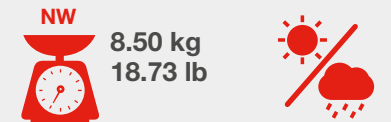
Blocage automatique des pieds en position d'usage.

Automatische Feststellung der aufgeklappten Tischbeine.

Height adjuster on 3 legs.

Regulador de altura incorporado en las 3 patas.

Régulateur de hauteur intégré aux 3 pieds.

Integrierte Höhenverstellung in den 3 Tischbeinen.Capacity: 2 persons.
Area per person: 28".**Capacidad: 2 personas.
Espacio por persona: 71.5 cm.**Capacité: 2 personnes.
Espace par personne: 71.5 cm.**Bietet Platz für 2 Personen.
Platz pro Person: 71.5 cm.**Multitrolley available for 15 tables.
See page 92.**Carro Multitrolley disponible para 15 mesas.
Ver página 92.**Chariot Multitrolley disponible pour 15 tables.
Voir page 92.**Wagen Multitrolley lieferbar für 15 Tische.
Siehe S. 92.**

Code PT-33-NC
Código
Code
Code

EAN 8436539306665

Name XXLcorner
Nombre new zown classic
Nom
Name

Units per box 1
Unidades por caja
Unités par boîte
Stückzahl pro Packung

Packaging size 93 x 94 x 6 cm
Medidas embalaje 37" x 36.6" x 2.5"
Dimensions emballage
Verpackungsmaße

Packaging volume 0.05 m³
Volumen embalaje 1.85 ft³
Volume d'emballage
Verpackungsvolumen

Gross weight 9.70 kg
Peso bruto 21.38 lb
Poids brut
Bruttogewicht

Loading quantity Container 40': 1076
Unidades por contenedor Container 40' HC: 1196
por contenedor
Unités par conteneur
Einheiten
pro Container

SHARK
GREYplanet120
new zown classic100%
PURE HDPE.
NOT MIXED581-1
581-3 Contract
15372 L2ø 122 cm
ø 4'Table top "L shape" beam:
W41.5 x H41.5 x TH2.5 mmLeg crossbar:
ø19.1 x TH1.0 mmLeg axis:
ø22.2 x TH1.0 mmLeg tube:
ø28.6 x TH1.0 mm

stretch



| | | | | | | | |
|-------------|------|------|------|------|------|------|------|
| table cover | 0226 | 1008 | 1006 | 1005 | 0223 | 1007 | 0222 |
| top cover | 0466 | 1012 | 1010 | 1009 | 0463 | 1011 | 0462 |



paramount



| | | | | | | | |
|-------------|------|------|------|------|------|------|------|
| table cover | 0135 | 1016 | 1015 | 0138 | 0136 | 0140 | 0139 |
| tablecloth | 0551 | | | | | | |

160 x 160 cm
63" x 63"

plain



| | | | | | | | |
|-------------|------|------|------|------|------|------|------|
| table cover | 0356 | 1014 | 1013 | 0359 | 0357 | 0361 | 0360 |
| tablecloth | 0551 | | | | | | |

160 x 160 cm
63" x 63"

Ergonomic frame design.

Diseño ergonómico de la estructura.

Design ergonomique de la structure.

Ergonomisches Gestelldesign.

New and very smooth manual locking mechanism. Includes automatic sliding rings to prevent undesired folding.

Nuevo bloqueador manual de manejo muy suave. Incluye argollas autodeslizantes de seguridad para evitar el plegado involuntario.

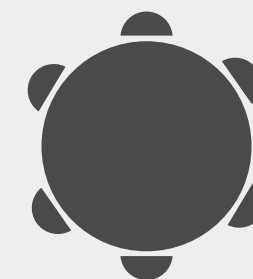
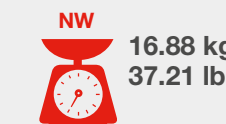
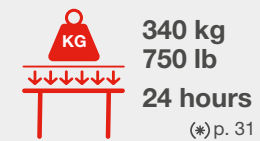
Nouveau mécanisme de blocage manuel au maniement très doux. Il inclut des anneaux autoglossants de sécurité pour éviter le pliage involontaire.

Neue, sehr leichtgängige, manuelle Verriegelung. Mit selbstgleitenden Sicherheitsringen, die ein unerwünschtes Zusammenklappen verhindern.

Integrated foot pads.

Tacos de las patas integrados.

Embouts des pieds intégrés.

In den Beinen integrierte Schutzkappen.Planetrolley available for 16 tables.
See page 90.**Carro planetrolley disponible para 16 mesas. Ver página 90.**Chariot planetrolley disponible pour 16 tables.
Voir page 90.**Wagen planetrolley lieferbar für 16 Tische. Siehe S. 90.**Capacity: 6 persons.
Area per person: 25".**Capacidad: 6 personas. Espacio por persona: 64 cm.**Capacité: 6 personnes.
Espace par personne: 64 cm.**Bietet Platz für 6 Personen. Platz pro Person: 64 cm.**Multitrolley available for 15 tables.
See page 92.**Carro Multitrolley disponible para 15 mesas. Ver página 92.**Chariot Multitrolley disponible pour 15 tables.
Voir page 92.**Wagen Multitrolley lieferbar für 15 Tische. Siehe S. 92.****Limited 10 year warranty**Code
Código
Code
Code

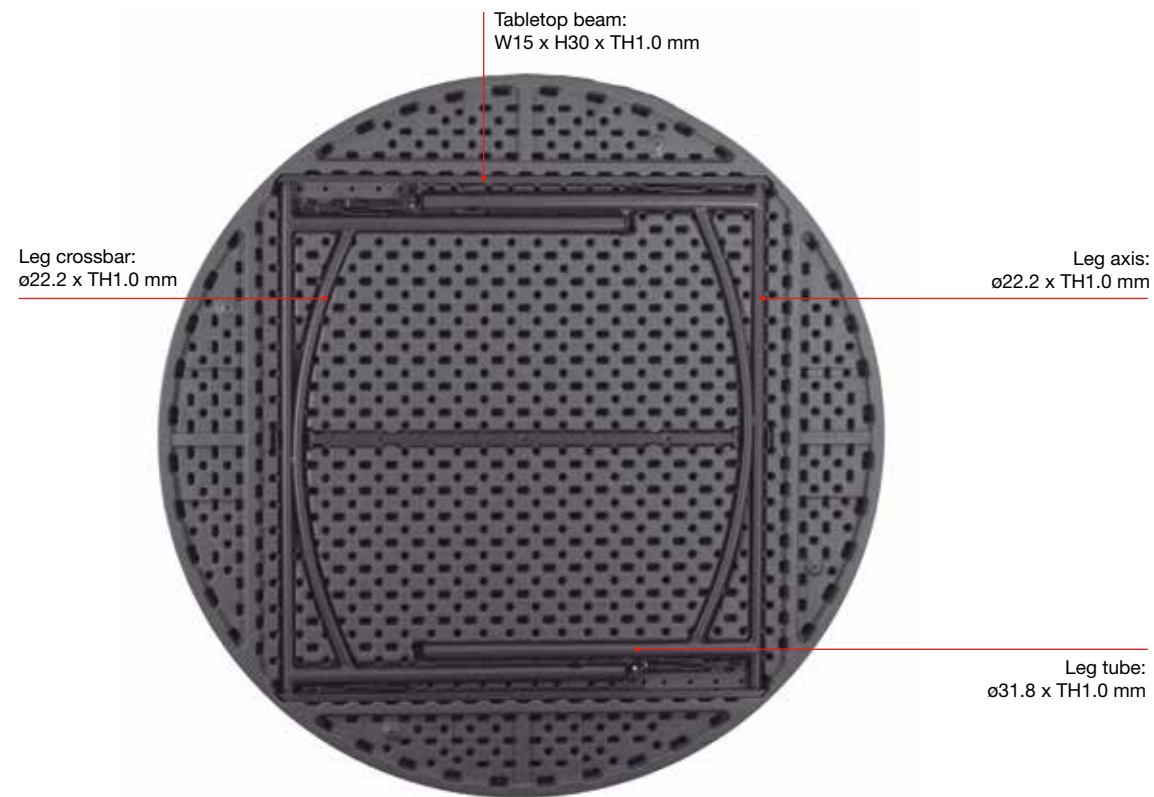
BT-48J-NC

EAN 8436539306689

Name
Nombre
Nom
Nameplanet120
new zown classicUnits per box
Unidades por caja
Unités par boîte
Stückzahl pro Packung

1

Packaging size
Medidas embalaje
Dimensions emballage
Verpackungsmaße124.5 x 124.5 x 6.4 cm
49" x 49" x 2.5"Packaging volume
Volumen embalaje
Volume d'emballage
Verpackungsvolumen0.10 m³
3.53 ft³Gross weight
Peso bruto
Poids brut
Bruttogewicht18.40 kg
40.56 lbLoading quantity
Unidades
por contenedor
Unités par conteneur
Einheiten
pro ContainerContainer 40': 505
Container 40' HC: 700

SHARK
GREYplanet**150**
new zown classic100%
PURE HDPE.
NOT MIXED581-1
581-3 Contract
15372 L2

stretch



| | | | | | | | |
|-------------|------|------|------|------|------|------|------|
| table cover | 0233 | 1020 | 1018 | 1017 | 0230 | 1019 | 0229 |
| top cover | 0473 | 1024 | 1022 | 1021 | 0470 | 1023 | 0469 |



paramount



| | | | | | | | |
|-------------|------|------|------|------|------|------|------|
| table cover | 0141 | 1028 | 1027 | 0144 | 0142 | 0146 | 0145 |
| tablecloth | 0552 | | | | | | |

190 x 190 cm
74.8" x 74.8"

plain



| | | | | | | | |
|-------------|------|------|------|------|------|------|------|
| table cover | 0362 | 1026 | 1025 | 0365 | 0363 | 0367 | 0366 |
| tablecloth | 0552 | | | | | | |

190 x 190 cm
74.8" x 74.8"

Ergonomic frame design.

Diseño ergonómico de la estructura.

Design ergonomique de la structure.

Ergonomisches Gestelldesign.

New and very smooth manual locking mechanism. Includes automatic sliding rings to prevent undesired folding.

Nuevo bloqueador manual de manejo muy suave. Incluye argollas autodeslizantes de seguridad para evitar el plegado involuntario.

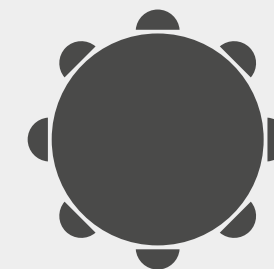
Nouveau mécanisme de blocage manuel au maniement très doux. Il inclut des anneaux autoglissant de sécurité pour éviter le pliage involontaire.

Neue, sehr leichtgängige, manuelle Verriegelung. Mit selbstgleitenden Sicherheitsringen, die ein unerwünschtes Zusammenklappen verhindern.

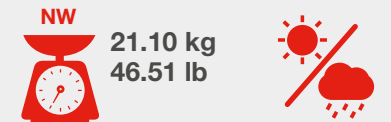
Integrated foot pads.

Tacos de las patas integrados.

Embouts des pieds intégrés.

In den Beinen integrierte Schutzkappen.Planetrolley available for 14 tables.
See page 90.**Carro planetrolley disponible para 14 mesas. Ver pág. 90.**Chariot planetrolley disponible pour 14 tables.
Voir page 90.**Wagen planetrolley lieferbar für 14 Tische. Siehe S. 90.**Capacity: 8 persons.
Area per person: 23.5".**Capacidad: 8 personas. Espacio por persona: 59.7 cm.**Capacité: 8 personnes.
Espace par personne: 59.7 cm.**Bietet Platz für 8 Personen. Platz pro Person: 59.7 cm.**Multitrolley available for 13 tables.
See page 92.**Carro Multitrolley disponible para 13 mesas. Ver página 92.**Chariot Multitrolley disponible pour 13 tables.
Voir page 92.**Wagen Multitrolley lieferbar für 13 Tische. Siehe S. 92.**

340 kg
750 lb
24 hours
(*) p. 31



NW
21.10 kg
46.51 lb



10 Limited 10 year warranty

| | |
|--------|-----------|
| Code | BT-60J-NC |
| Código | |
| Code | |
| Code | |

| | |
|-----|---------------|
| EAN | 8436539306696 |
|-----|---------------|

| | |
|--------|-------------------|
| Name | planet 150 |
| Nombre | new zown classic |
| Nom | |
| Name | |

| | |
|-----------------------|---|
| Units per box | 1 |
| Unidades por caja | |
| Unités par boîte | |
| Stückzahl pro Packung | |

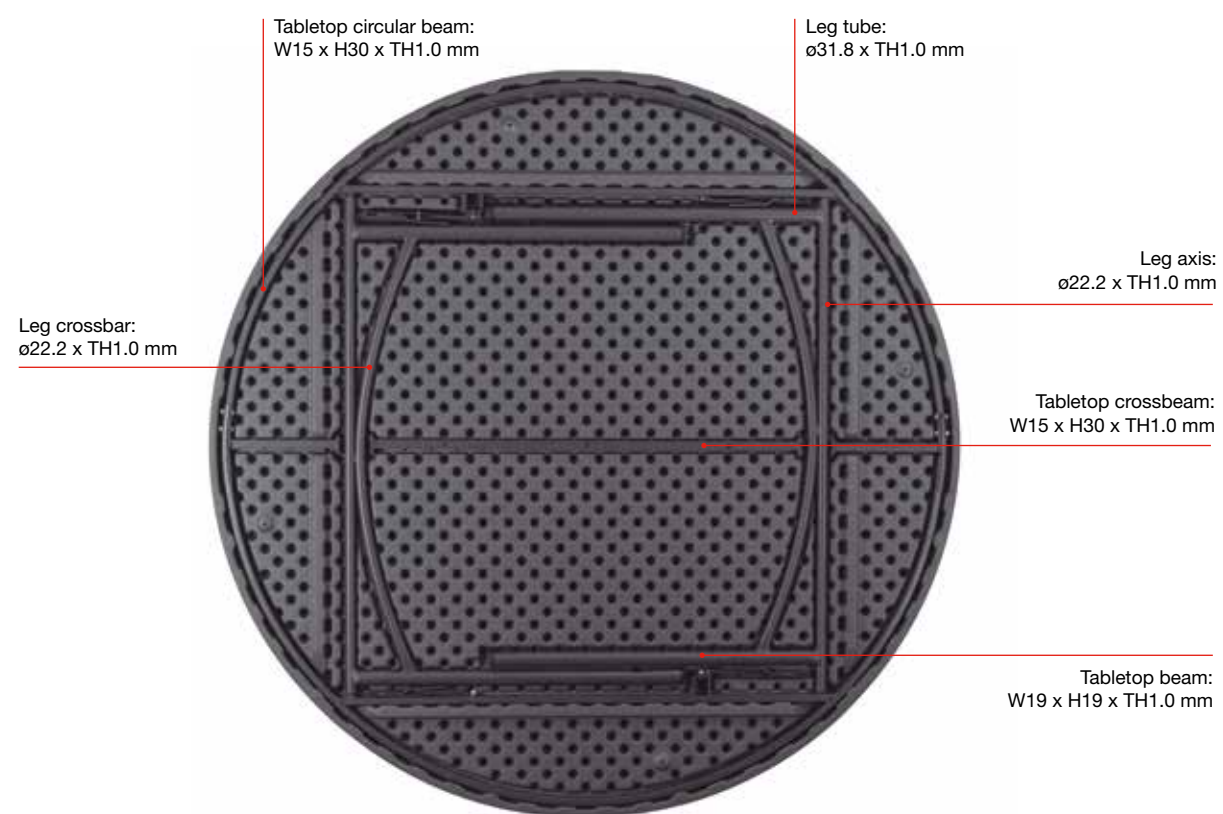
| | |
|----------------------|----------------------|
| Packaging size | 154.9 x 154.9 x 7 cm |
| Medidas embalaje | 61" x 61" x 2.8" |
| Dimensions emballage | |
| Verpackungsmaße | |

| | |
|--------------------|---------------------|
| Packaging volume | 0.17 m ³ |
| Volumen embalaje | 6 ft ³ |
| Volume d'emballage | |
| Verpackungsvolumen | |

| | |
|---------------|----------|
| Gross weight | 24.88 kg |
| Peso bruto | 54.85 lb |
| Poids brut | |
| Bruttogewicht | |

| | |
|-------------------------|-----------------------|
| Loading quantity | Container 40': 320 |
| Unidades por contenedor | Container 40' HC: 360 |
| Unités par conteneur | |
| Einheiten pro Container | |



SHARK
GREYplanet**160**
new zown classic100%
PURE HDPE.
NOT MIXED581-1
581-3 Contract
15372 L2

stretch



| | | | | | | | |
|-------------|------|------|------|------|------|------|------|
| table cover | 0240 | 1032 | 1030 | 1029 | 0237 | 1031 | 0236 |
| top cover | 0480 | 1036 | 1034 | 1033 | 0477 | 1035 | 0476 |



paramount



| | | | | | | | |
|-------------|------|------|------|------|------|------|------|
| table cover | 0147 | 1040 | 1039 | 0150 | 0148 | 0152 | 0151 |
| tablecloth | 0553 | | | | | | |

200 x 200 cm
78.75" x 78.75"

plain



| | | | | | | | |
|-------------|------|------|------|------|------|------|------|
| table cover | 0368 | 1038 | 1037 | 0371 | 0369 | 0373 | 0372 |
| tablecloth | 0553 | | | | | | |

200 x 200 cm
78.75" x 78.75"

Ergonomic frame design.

Diseño ergonómico de la estructura.

Design ergonomique de la structure.

Ergonomisches Gestelldesign.

New and very smooth manual locking mechanism. Includes automatic sliding rings to prevent undesired folding.

Nuevo bloqueador manual de manejo muy suave. Incluye argollas autodeslizantes de seguridad para evitar el plegado involuntario.

Nouveau mécanisme de blocage manuel au maniement très doux. Il inclut des anneaux autoglisants de sécurité pour éviter le pliage involontaire.

Neue, sehr leichtgängige, manuelle Verriegelung. Mit selbstgleitenden Sicherheitsringen, die ein unerwünschtes Zusammenklappen verhindern.

Integrated foot pads.

Tacos de las patas integrados.

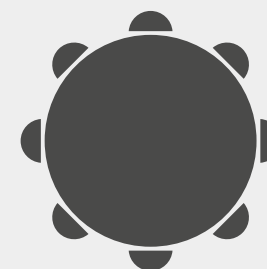
Embouts des pieds intégrés.

In den Beinen integrierte Schutzkappen.

Planetrolley available for 14 tables. See page 90.

Carro planetrolley disponible para 14 mesas. Ver pág. 90.

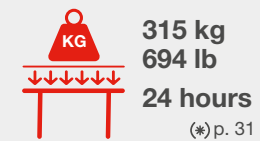
Chariot planetrolley disponible pour 14 tables. Voir page 90.

Wagen planetrolley lieferbar für 14 Tische. Siehe S. 90.Capacity: 8 persons.
Area per person: 24.7".**Capacidad: 8 personas. Espacio por persona: 62.8 cm.**Capacité: 8 personnes.
Espace par personne: 62.8 cm.**Bietet Platz für 8 Personen. Platz pro Person: 62.8 cm.**

Multitrolley available for 13 tables. See page 92.

Carro Multitrolley disponible para 13 mesas. Ver página 92.

Chariot Multitrolley disponible pour 13 tables. Voir page 92.

Wagen Multitrolley lieferbar für 13 Tische. Siehe S. 92.**Limited 10 year warranty**Code
Código
Code
Code

BT-63-NC

EAN 8436539306702

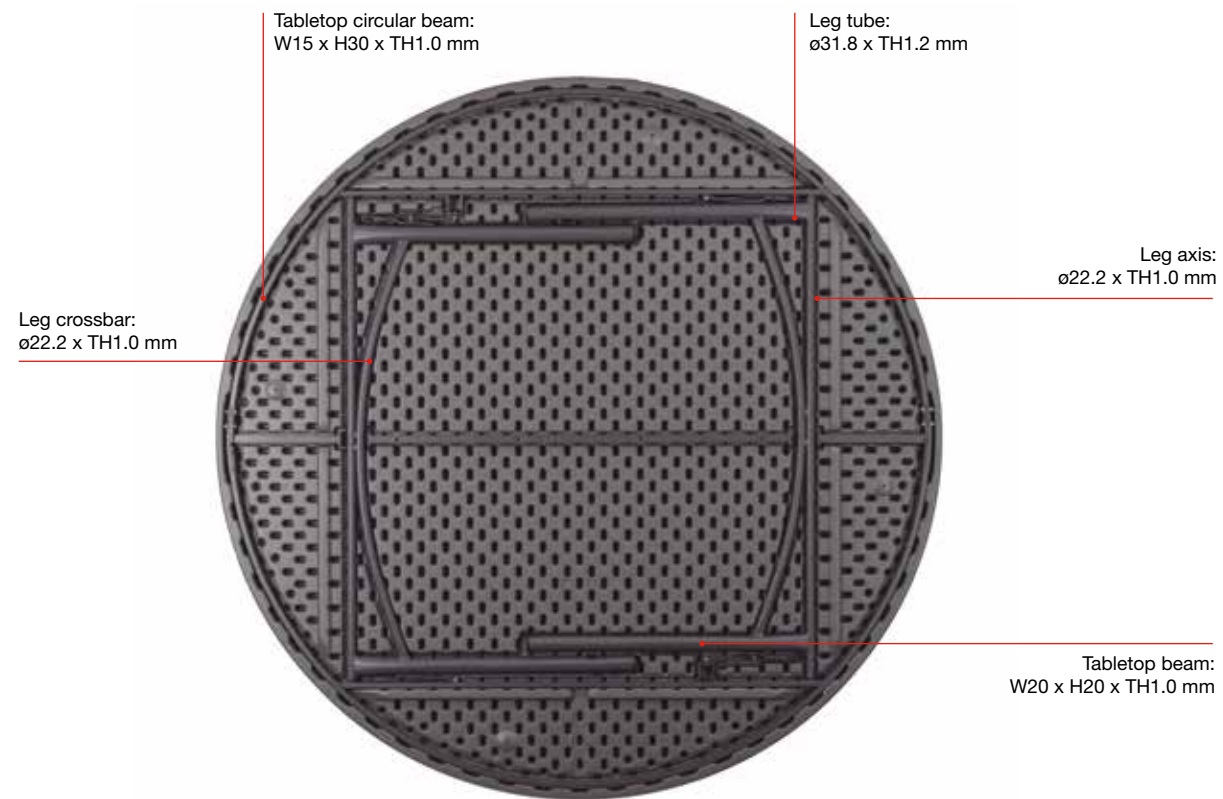
Name
Nombre
Nom
Nameplanet**160**
new zown classicUnits per box
Unidades por caja
Unités par boîte
Stückzahl pro Packung

1

Packaging size
Medidas embalaje
Dimensions emballage
Verpackungsmaße163.3 x 162.6 x 7 cm
64.3" x 64" x 2.8"Packaging volume
Volumen embalaje
Volume d'emballage
Verpackungsvolumen0.18 m³
6.54 ft³Gross weight
Peso bruto
Poids brut
Bruttogewicht28.90 kg
63.71 lbLoading quantity
Unidades
por contenedor
Unités par conteneur
Einheiten
pro ContainerContainer 40': 308
Container 40' HC: 336

planet180

new zown classic

SHARK
GREY100%
PURE HDPE.
NOT MIXED581-1
581-3 Contract
15372 L2

stretch



table cover 0247 1044 1042 1041 0244 1043 0243

top cover 0487 1048 1046 1045 0484 1047 0483



paramount



table cover 0153 1052 1051 0156 0154 0158 0157

tablecloth 0554

220 x 220 cm
86.6" x 86.6"

plain



table cover 0374 1050 1049 0377 0375 0379 0378

tablecloth 0554

220 x 220 cm
86.6" x 86.6"

Ergonomic frame design.

Diseño ergonómico de la estructura.

Design ergonomique de la structure.

Ergonomisches Gestelldesign.

New and very smooth manual locking mechanism. Includes automatic sliding rings to prevent undesired folding.

Nuevo bloqueador manual de manejo muy suave. Incluye argollas autodeslizantes de seguridad para evitar el plegado involuntario.

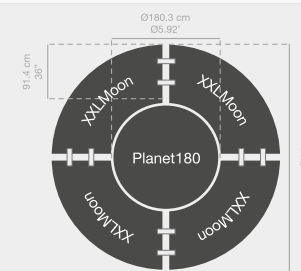
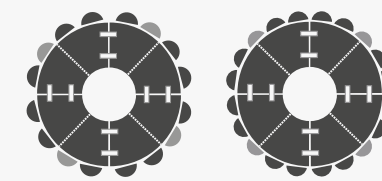
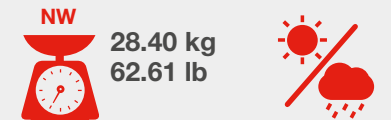
Nouveau mécanisme de blocage manuel au maniement très doux. Il inclut des anneaux autoglissant de sécurité pour éviter le pliage involontaire.

Neue, sehr leichtgängige, manuelle Verriegelung. Mit selbstgleitenden Sicherheitsringen, die ein unerwünschtes Zusammenklappen verhindern.

Integrated foot pads.

Tacos de las patas integrados.

Embouts des pieds intégrés.

In den Beinen integrierte Schutzkappen.Planet trolley available for 13 tables.
See page 90.**Carro planet trolley disponible para 13 mesas. Ver pág. 90.**Chariot planet trolley disponible pour 13 tables.
Voir page 90.**Wagen planet trolley lieferbar für 13 Tische. Siehe S. 90.**Capacity: 10 persons.
Area per person: 22.3".**Capacidad: 10 personas. Espacio por persona: 56.6 cm.**Capacité: 10 personnes.
Espace par personne: 56.6 cm.**Bietet Platz für 10 Personen. Platz pro Person: 56.6 cm.**Circular joining of four XXLmoon tables with 1 planet180 table.
Capacity for 12 to 20 persons.**Unión circular de 4 mesas XXLmoon con 1 mesa planet180. Capacidad 12 a 20 personas.**Raccord circulaire de 4 tables XXLmoon avec 1 table planet180.
Capacité 12 à 20 personnes.**Kreisförmige Verbindung von 4 Tischen XXLmoon mit einem Tisch planet180. Bietet Platz für 12 bis 20 Personen.**Multitrolley available for 12 tables.
See page 92.**Carro Multitrolley disponible para 12 mesas. Ver página 92.**Chariot Multitrolley disponible pour 12 tables.
Voir page 92.**Wagen Multitrolley lieferbar für 12 Tische. Siehe S. 92.**Code
Código
Code
Code

BT-71-NC

EAN 8436539306719

Name
Nombre
Nom
Name

planet180

new zown classic

Units per box 1

Unidades por caja

Unités par boîte

Stückzahl pro Packung

Packaging size 183 x 183 x 7.3 cm

Medidas embalaje 72" x 72" x 2.8"

Dimensions emballage

Verpackungsmaße

Packaging volume 0.24 m³Volumen embalaje 8.58 ft³

Volume d'emballage

Verpackungsvolumen

Gross weight 33.84 kg

Peso bruto 74.60 lb

Poids brut

Bruttogewicht

Loading quantity Container 40': 241

Unidades por contenedor Container 40' HC: 265

por contenedor

Unités par conteneur

Einheiten

pro Container



planet**trolley**100%
POWDER
COATED
STEEL

16121 L2

L(132 + 30) x W83.2 cm
L(52" + 11.8") x W32.7"31.30 kg
69 lb

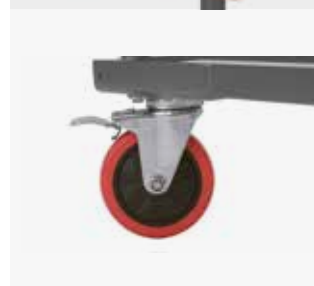
| Code Código Code Code | EAN | Name Nombre Nom Name | Units per box Unidades por caja Unités par boîte Stückzahl pro Packung | Packaging size Medidas embalaje Dimensions emballage Verpackungsmaße | Packaging volume Volumen embalaje Volume d'emballage Verpackungsvolumen | Gross weight Peso bruto Poids brut Bruttogewicht | Loading quantity Unidades por contenedor Unités par conteneur Einheiten pro Container |
|--------------------------------|---------------|-------------------------------|---|---|--|---|--|
| RA-106A | 8437009886090 | planet trolley | 1 | 135.7 x 87.6 x 12.7 cm 53.5" x 34.5" x 5" | 0.15 m ³ 5.29 ft ³ | 34.10 kg 75.17 lb | Container 40': 396 Container 40' HC: 460 |



Extendable handle.
Asa extensible.
Anse extensible.
Ausziehbarer Griff.



Large loading platform.
Amplia plataforma de apoyo.
Large plateau de support.
Breite Ladefläche.



Four polyurethane wheels with built-in brake
(Two fixed wheels and two pivoting wheels).

4 ruedas de poliuretano con freno incorporado (2 ruedas fijas y 2 ruedas pivotantes).

4 roues en polyuréthane avec frein intégré
(2 roues fixes et 2 roues pivotantes).

4 PU-Räder mit integrierter Bremse (2 feststehende Räder und 2 Schwenkräder).



Polyester strap with tensioning mechanism to hold the tables in an upright position when the trolley is half loaded.

Correa de poliéster con tensor para mantener las mesas verticales si el carro está a media carga.

Courroie en polyester avec tendeur pour le maintien vertical des tables lorsque le chariot est à moitié plein.

Spannriemen aus Polyester zur Befestigung der senkrecht aufgestellten Tische, wenn der Wagen nur halbvoll ist.



Capacity: 16 pcs. Planet120, 14 pcs. Planet150, 14 pcs. Planet160, 13 pcs. Planet180.

Capacidad: 16u. Planet120, 14u. Planet150, 14u. Planet160, 13u. Planet180.

Capacité: 16u. Planet120, 14u. Planet150, 14u. Planet160, 13u. Planet180.

Fassungsvermögen: 16 Stk. Planet120, 14 Stk. Planet150, 14 Stk. Planet160, 13 Stk. Planet180.



Horizontal bar to secure tables in place and prevent them from moving.

Barra horizontal para inmovilizar las mesas y evitar que se desplacen.

Barre horizontale pour immobiliser les tables et éviter qu'elles se déplacent.

Horizontale Anschlagstange für die Tische, um ein Verschieben derselben zu vermeiden.



multitrolley

NEW

100%
POWDER
COATED
STEEL

16121 L2

51.20 kg
112.87 lb

| Code Código Code | EAN | Name Nombre Nom Name | Units per box Unidades por caja Unités par boîte Stückzahl pro Packung | Packaging size Medidas embalaje Dimensions emballage Verpackungsmaße | Packaging volume Volumen embalaje Volume d'emballage Verpackungsvolumen | Gross weight Peso bruto Poids brut Bruttogewicht | Loading quantity Unidades por contenedor Unités par conteneur Einheiten pro Container |
|------------------------|---------------|-------------------------------|---|---|--|---|--|
| CB034F001A | 8436539309666 | multitrolley | 1 | 182.8 x 88.9 x 21.60 cm 72" x 35" x 8.5" | 0.35 m ³ 12.40 ft ³ | 55.82 kg 123 lb | Container 40': 158 Container 40' HC: 170 |



Folding trolley with extendable base to store and transport a wide variety of Zown tables and benches.

Carro plegable con base extensible para almacenar y transportar una gran variedad de mesas y bancos Zown.

Chariot pliable avec base extensible pour entreposer et transporter une grande variété de tables et de bancs Zown.

Klappwagen mit ausziehbarer Ladefläche zum Aufbewahren und Transportieren einer breiten Vielfalt an Zown-Bänken und -Tischen.

Capacity / **Capacidad** / **Capacité** / **Fassungsvermögen:**

L120 15 pcs, M183 15 pcs, Planet120 15 pcs, Planet150 13 pcs, Planet160 13 pcs, Planet180 12 pcs, XL120 15 pcs, XL150 15 pcs, XL180 14 pcs, XL240 13 pcs, XXL90 15 pcs, XXL180 15 pcs, XXL200 15 pcs, XXL240 13 pcs, XLCorner 15 pcs, XXLCorner 15 pcs, XLMoon 6 pcs, XXLMoon 6 pcs, Planet4 13 pcs, Planet5 12 pcs, Planet6 13 pcs, XL4 12 pcs, XL6 13 pcs, XL8 13 pcs, XXL3 26 pcs (2 pilas), XL4 12 pcs, XXL4.5 13 pcs, XXL6 13 pcs, XLAngle 13 pcs, XLCrescent 13 pcs, Munich50 13 pcs, Munich70 13 pcs, Munichbench 28 pcs (2 stacks), Sharpbench180 28 pcs (2 stacks), Sharpbench240 16 pcs (2 stacks), Oktober175 30 pcs.



Extendable base that allows tables 120 to 240 cm long to be stored and transported. The extension mechanism can be positioned at any point thanks to the new locking system.

Base extensible que permite almacenar y transportar mesas de longitudes comprendidas entre 120 a 240 cm. El mecanismo de extensión es posicionable en cualquier punto deseado gracias al nuevo sistema bloqueador.

Base extensible qui permet d'entreposer et de transporter des tables aux longueurs comprises entre 120 et 240 cm. Le mécanisme d'extension peut être positionné à tout point désiré grâce au nouveau système de blocage.

Ausziehbare Ladefläche zum Aufbewahren und Transportieren von Tischen mit einer Länge von 120 bis 240 cm. Dank des neuen Blockiersystems lässt sich die Ausziehvorrückung auf jede Länge einstellen.



Fully foldable trolley. It takes up minimal space and all its parts are integrated to prevent them from getting lost.

Carro totalmente plegable. Ocupa mínimo espacio y todos sus componentes quedan integrados para no extraviarlos.

Chariot complètement pliable. Il occupe un minimum d'espace et tous ses composants sont intégrés afin de ne pas les perdre.

Vollständig zusammenklappbarer Wagen. Minimaler Platzbedarf und alle Bauteile bleiben integriert, sodass sie nicht verloren gehen.



4 rubber wheels with built-in brake (2 fixed wheels and 2 pivoting wheels).

4 ruedas de caucho con freno incorporado. (2 ruedas fijas y 2 ruedas pivotantes).

4 roues en caoutchouc avec frein incorporé. (2 roues fixes et 2 roues pivotantes).

4 Gummiräder mit integrierter Bremse (2 feststehende Räder und 2 Schwenkräder).



Platform and poles protected with anti-slip material.

Plataforma y postes protegidos con material antideslizante.

Plateforme et poteaux protégés par un matériau antidérapant.

Schutzverkleidung aus rutschfestem Material für Auflagefläche und Ständer.



Central rail can be put in various positions to keep the tables upright when the trolley is at half load.

Barandilla central posicionable en varios puntos para mantener las mesas en posición vertical cuando el carro está a media carga.

Garde-corps central positionnable en différents points pour maintenir les tables en position verticale lorsque le chariot est à moitié chargé.

Verstellbare Sicherungsstange mit verschiedenen Befestigungspunkten, damit die Tische auch bei halb beladenem Wagen in senkrechter Position bleiben.



SHARK
GREY

cocktail80

new zown classic

100%
PURE HDPE.
NOT MIXED



581-1
581-3 Contract
15372 L2



U-shaped plate:
ø25.4 x TH1.0 mm

Tabletop crossbeam:
W10 x H20 x TH1.0 mm

Leg tube:
ø25.4 x TH1.0 mm

Tabletop beam:
W10 x H20 x TH1.0 mm

Open-position
blocking device

Leg crossbar:
ø19.1 x TH1.0 mm

stretch

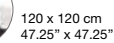


- table cover: 0296, 1056, 1054, 1053, 0293, 1055, 0292
- top cover: 0543, 1060, 1058, 1057, 0540, 1059, 0539

paramount



- table cover: 0111, 1064, 1063, 0114, 0112, 0116, 0115
- tablecloth: 0547



120 x 120 cm
47.25" x 47.25"

plain



- table cover: 0326, 1062, 1061, 0329, 0327, 0331, 0330
- tablecloth: 0547



120 x 120 cm
47.25" x 47.25"



Light and easy to fold and store.

Ligera y fácil de plegar y guardar.

Légère, facile à plier et à ranger.

Leicht und einfach zusammenzuklappen und zu verstauen.



Large base which provides great stability.

Base amplia que proporciona gran estabilidad.

Base large qui confère une grande stabilité.

Eine breite Standfläche sorgt für eine ausgezeichnete Standfestigkeit.

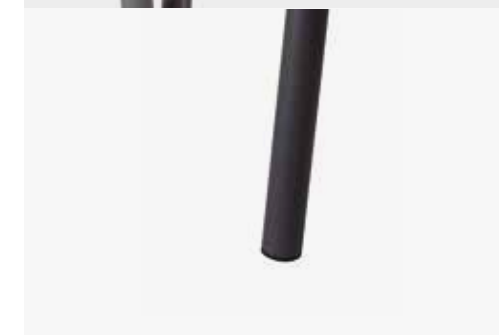


Manual lock for legs when in use.

Bloqueador de las patas en posición de uso.

Blocage des pieds en position d'utilisation.

Arretierung für Tischbeine in aufgeklappter Position.



Integrated foot pads.

Tacos de las patas integrados.

Embouts des pieds intégrés.

In den Beinen integrierte Schutzkappen.



Cocktailtrolley available for 20 tables.
See page 104.

**Carro Cocktailtrolley disponible para 20 mesas.
Ver pág. 104.**

Chariot Cocktailtrolley disponible pour 20 tables.
Voir page 104.

**Wagen Cocktailtrolley lieferbar für 20 Tische.
Siehe S. 104.**

170 kg
375 lb
24 hours
(*) p. 31

8.38 kg
18.47 lb



10 Limited 10 year warranty

Code PT-36-NC
Código
Code
Code

EAN 8436539306733

Name cocktail80
Nombre new zown classic
Nom
Name

Units per box 1
Unidades por caja
Unités par boîte
Stückzahl pro Packung

Packaging size 141 x 82.9 x 7 cm
Medidas embalaje 55.5" x 32.6" x 2.7"
Dimensions emballage
Verpackungsmaße

Packaging volume 0.08 m³
Volumen embalaje 2.89 ft³
Volume d'emballage
Verpackungsvolumen

Gross weight 10.30 kg
Peso bruto 22.70 lb
Poids brut
Bruttogewicht

Loading quantity Container 40': 750
Unidades por contenedor Container 40' HC: 870

Unités par conteneur
Einheiten
pro Container

alvarstool

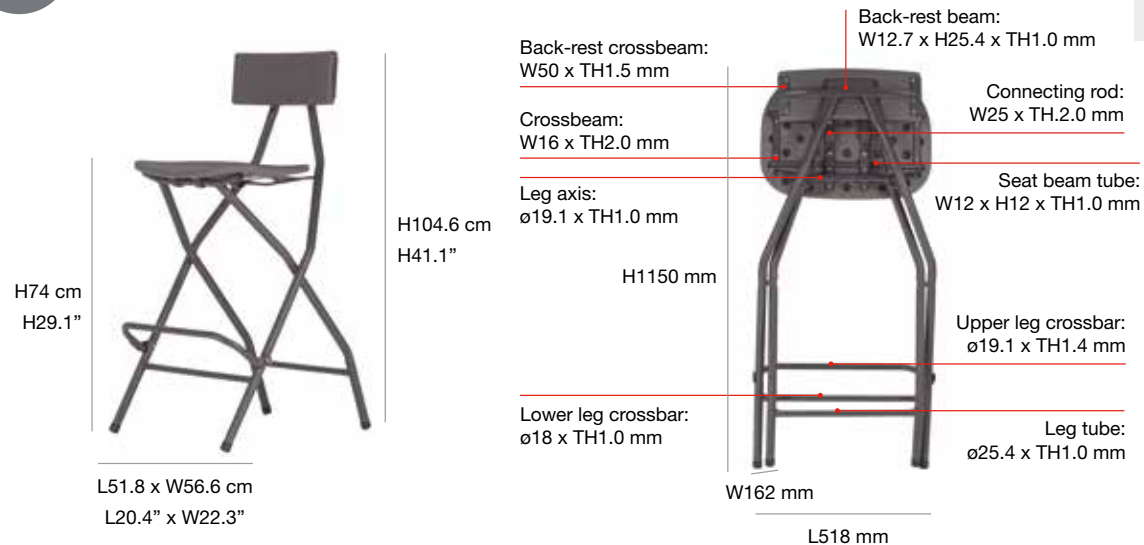
new zown classic

SHARK
GREY

100%
PURE HDPE.
NOT MIXED



581-1
581-3 Contract
16139 L1



181 kg
 400 lb
 24 hours
(*) p. 31

6.55 kg
 14.44 lb

| Code Código Code Code | EAN | Name Nombre Nom Name | Units per box Unidades por caja Unités par boîte Stückzahl pro Packung | Packaging size Medidas embalaje Dimensions emballage Verpackungsmaße | Packaging volume Volumen embalaje Volume d'emballage Verpackungsvolumen | Gross weight Peso bruto Poids brut Bruttogewicht | Loading quantity Unidades por contenedor Unités par conteneur Einheiten pro Container |
|--------------------------------|---------------|-------------------------------|---|---|--|---|--|
| PC-019-SG | 8436539306795 | alvarstool | 2 | 140.65 x 53 x 18.4 cm 5.3" x 20.87" x 7.25" | 0.13 m3 4.83 ft3 | 15.10 kg 33.28 lb | Container 40': 856 Container 40' HC: 980 |



Fold-down footrest to optimise folding.

Reposapiés abatible para optimizar el plegado.

Repose-pièds rabattable pour replier le tabouret de façon optimale.

Klappbare Fußraste zum optimalen Zusammenklappen.

Spacious and comfortable seat.

Asiento amplio y confortable.

Siège large et confortable.

Breiter und bequemer Sitz.

Easy to fold, transport and store.

Fácil de plegar, transportar y guardar.

Facile à plier, à transporter et à stocker.

Einfach zusammenzuklappen, zu transportieren und aufzubewahren.

stretch



- 0033
- 1068
- 1066
- 1065
- 0030
- 1067
- 0029

classic



- 0074
- 1070
- 1069
- 0077
- 0075
- 0079
- 0078

sashes



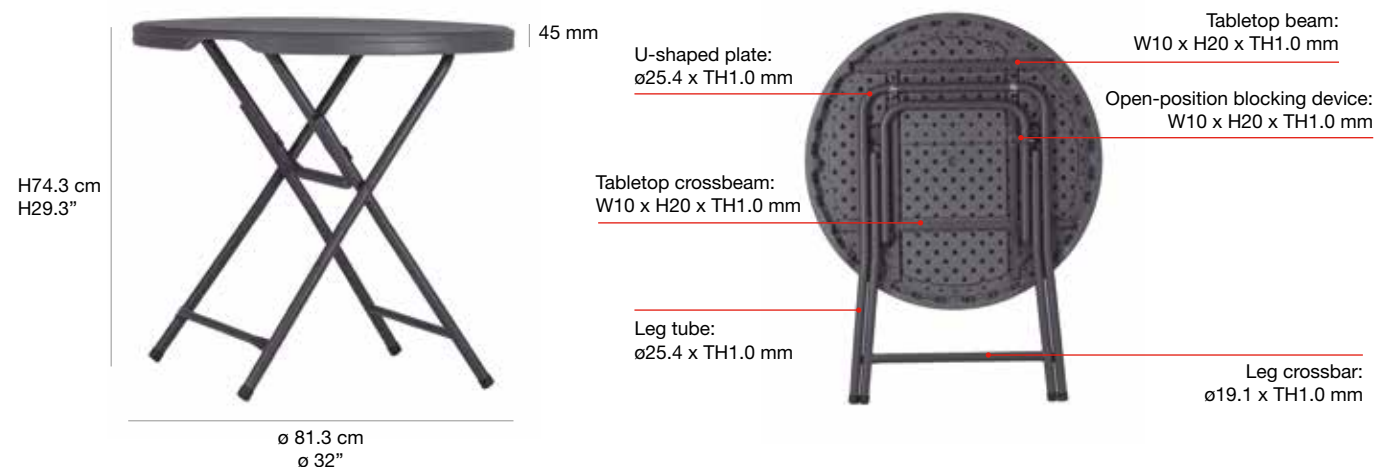
- | | | | | | | | |
|---------|------|------|------|------|------|------|------|
| classic | 0653 | 1171 | 1169 | 1168 | 0640 | 1170 | 0639 |
| twist | 0682 | 1175 | 1173 | 1172 | 0679 | 1174 | 0678 |
| plain | 0661 | 1179 | 1177 | 1176 | 0658 | 1178 | 0657 |





praxis80

new zown classic

SHARK
GREY100%
PURE HDPE.
NOT MIXED581-1
581-3 Contract
15372 L2227 kg
500 lb
24 hours
(*)p. 318.44 kg
18.60 lb

10

Limited 10 year
warranty

| Code Código Code Code | EAN | Name Nombre Nom Name | Units per box Unidades por caja Unités par boîte Stückzahl pro Packung | Packaging size Medidas embalaje Dimensions emballage Verpackungsmaße | Packaging volume Volumen embalaje Volume d'emballage Verpackungsvolumen | Gross weight Peso bruto Poids brut Bruttogewicht | Loading quantity Unidades por contenedor Unités par conteneur Einheiten pro Container |
|--------------------------------|---------------|-------------------------------|---|---|--|---|--|
| PT-37-NC | 8436539306740 | praxis80 new zown classic | 1 | 110.5 x 82.7 x 6.7 cm 43.5" x 32.6" x 2.6" | 0.06 m ³ 2.12 ft ³ | 9.80 kg 21.60 lb | Container 40': 968 Container 40' HC: 1112 |



Light and easy to fold and store.

Ligera y fácil de plegar y guardar.

Lègere, facile à plier et à ranger.

Leicht und einfach zusammenzuklappen und zu verstauen.

Manual lock for legs when in use.

Bloqueador de las patas en posición de uso.

Blocage des pieds en position d'utilisation.

Arretierung für Tischbeine in aufgeklappter Position.

Large base which provides great stability.

Base amplia que proporciona gran estabilidad.

Base large qui confère une grande stabilité.

Eine breite Standfläche sorgt für eine ausgezeichnete Standfestigkeit.Cocktailtrolley available for 20 tables.
See page 100.**Carro Cocktailtrolley disponible para 20 mesas. Ver pág. 100.**

Chariot Cocktailtrolley disponible pour 20 tables. Voir page 100.

Voir page 82. Wagen Cocktailtrolley lieferbar für 20 Tische. Siehe S. 100.

stretch



table cover 0303 1074 1072 1071 0300 1073 0299

top cover 0543 1060 1058 1057 0540 1059 0539

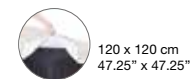


paramount



table cover 0159 1078 1077 0162 0160 0164 0163

tablecloth 0547

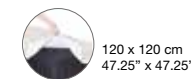
120 x 120 cm
47.25" x 47.25"

plain

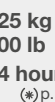
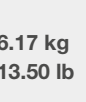


table cover 0380 1076 1075 0383 0381 0385 0384

tablecloth 0547

120 x 120 cm
47.25" x 47.25"

bistrot70

100%
PURE HDPE.
NOT MIXED581-1
581-3 Contract225 kg
500 lb
24 hours
(*)p. 316.17 kg
13.50 lb

10

Limited 10 year
warranty

| Code Código Code Code | EAN | Name Nombre Nom Name | Units per box Unidades por caja Unités par boîte Stückzahl pro Packung | Packaging size Medidas embalaje Dimensions emballage Verpackungsmaße | Packaging volume Volumen embalaje Volume d'emballage Verpackungsvolumen | Gross weight Peso bruto Poids brut Bruttogewicht | Loading quantity Unidades por contenedor Unités par conteneur Einheiten pro Container |
|--------------------------------|---------------|-------------------------------|---|---|--|---|--|
| BT009X001A-W | 8436539299653 | bistrot70 white | 1 | 70.20 x 6.03 x 102.9 cm 27.62" x 2.37" x 40.5" | 0.04 m ³ 1.41 ft ³ | 7.67 kg 16.90 lb | Container 40': 1420 Container 40' HC: 1590 |
| BT009X001A-DB | 8436539299660 | bistrot70 dark bronze | | | | | |



Easy to fold.

Fácil de plegar.

Facile à plier.

Einfach zusammenzuklappen.

Easy to transport and store.

Fácil de transportar y guardar.

Facile à transporter et à stocker.

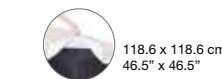
Einfach zu transportieren und aufzubewahren.Cocktailtrolley available for 20 tables.
See page 104.**Carro Cocktailtrolley disponible para 20 mesas. Ver pág. 104.**Chariot Cocktailtrolley disponible pour 20 tables.
Voir page 104.**Voir page 82. Wagen Cocktailtrolley lieferbar für 20 Tische. Siehe S. 104.**Capacity: 2 persons.
Area per person: 26".**Capacidad: 2 personas.
Espacio por persona: 66 cm.**Capacité: 2 personnes.
Espace par personne: 66 cm.**Bietet Platz für 2 Personen.
Platz pro Person: 66 cm.**HDPE White
POWDER-COATED
STEEL
WhiteHDPE Dark Bronze
POWDER-COATED
STEEL
Dark Bronze

plain



table cover 01140 01146 01145 01142 01141 01144 01143

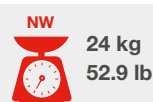
tablecloth 1609

118.6 x 118.6 cm
46.5" x 46.5"

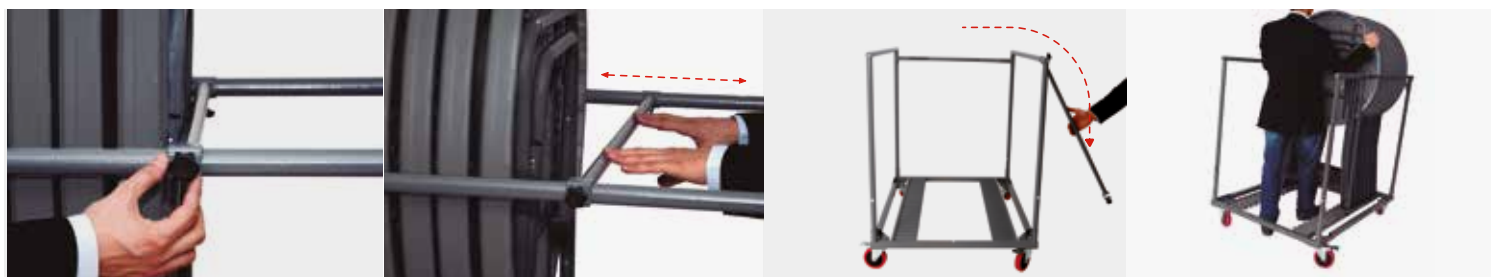


cocktail**trolley**100%
POWDER
COATED
STEEL

16121 L2

L125.5 x W89 cm
L49.4" x W35"
L51.9" x W24.4"24 kg
52.9 lb

| Code Código Code | EAN | Name Nombre Nom Name | Units per box Unidades por caja Unités par boîte Stückzahl pro Packung | Packaging size Medidas embalaje Dimensions emballage Verpackungsmaße | Packaging volume Volumen embalaje Volume d'emballage Verpackungsvolumen | Gross weight Peso bruto Poids brut Bruttogewicht | Loading quantity Unidades por contenedor Unités par conteneur Einheiten pro Container |
|------------------------|---------------|-------------------------------|---|---|--|---|--|
| RA-277 | 8437009886809 | cocktail trolley | 1 | 118.3 x 92.7 x 13 cm 46.6" x 36.6" x 5.125" | 0.14 m ³ 4.94 ft ³ | 27.54 kg 60.71 lb | Container 40': 408 Container 40' HC: 476 |

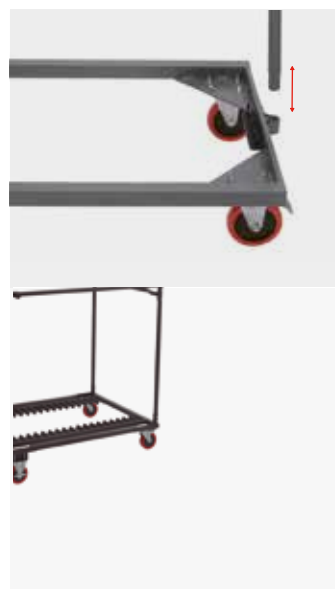


Locking bar which moves along the side rails to fix the tables in position even at half load. The bar revolves around one of the rails to allow access to the back of the trolley, making it easier to load.

Barra bloqueadora que se desliza a lo largo de las barandillas laterales para fijar las mesas incluso a media carga. La barra pivota en una de las barandillas para dejar acceso libre hasta el fondo del carro para facilitar la carga.

Barre bloquante se déplaçant le long des rampes latérales afin de fixer les tables, y compris en demie charge. La barre pivote sur une des rampes afin de laisser accès libre jusqu'au fond du chariot et faciliter ainsi le chargement.

Am Rahmen verschiebbare Sicherungsstange zur Sicherung der Tische auch bei halber Wagenladung. Die Sicherungsstange lässt sich an einer Rahmenseite schwenken. Dadurch wird der Zutritt bis zum hinteren Ende des Wagens ermöglicht und das Auf- und Abladen erleichtert.



Base with 4° angle of inclination to keep the tables upright when loaded.

Base con 4° de inclinación para mantener las mesas verticales durante la carga.

Support d'une inclinaison de 4°, servant à tenir les tables à la verticale pendant le chargement.

Auflage mit 4° Neigung, um die Tische beim Laden senkrecht zu halten.

Grooved base to prevent the tables from slipping.

Base dentada para evitar que las mesas resbalen.

Support crénelé servant à empêcher que les tables ne glissent.

Gezackte Auflage, damit die Tische nicht verrutschen können.



Capacity: 20 units of the cocktail**80**, praxis**80** or bistrot**70** tables.

Capacidad: 20 u. mesas cocktail80, praxis80 o bistrot70.

Capacité: 20 unités de tables cocktail**80**, praxis**80** ou bistrot**70**.

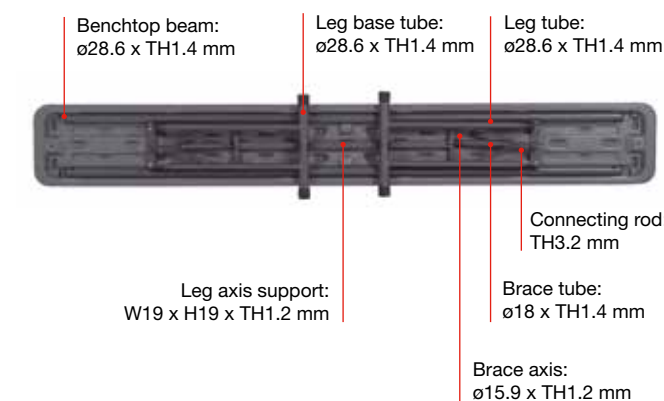
Kapazität: 20 cocktail80, praxis80 - oder bistrot70-Tische.

4 polyurethane wheels with built-in brake. (2 fixed wheels and 2 pivoting wheels). The 4 wheels have a diameter of 12.7 cm/5".

4 ruedas de poliuretano con freno incorporado (2 ruedas fijas y 2 ruedas pivotantes). Las 4 ruedas tienen un diámetro de 12.7 cm/5".

4 roues en polyuréthane avec frein intégré. (2 roues fixes et 2 roues pivotantes). Les 4 roues ont un diamètre de 12,7 cm/5".

4 PU-Räder mit integrierter Bremse. (2 feststehende Räder und 2 Schwenkräder). Die 4 Räder haben einen Durchmesser von 12,7 cm/5".

oktober**175**
new zown classic100%
PURE HDPE.
NOT MIXED581-1
581-2 Contract
16139 L1SHARK
GREY

| Code Código Code | EAN | Name Nombre Nom Name | Units per box Unidades por caja Unités par boîte Stückzahl pro Packung | Packaging size Medidas embalaje Dimensions emballage Verpackungsmaße | Packaging volume Volumen embalaje Volume d'emballage Verpackungsvolumen | Gross weight Peso bruto Poids brut Bruttogewicht | Loading quantity Unidades por contenedor Unités par conteneur Einheiten pro Container |
|------------------------|---------------|----------------------------------|---|---|--|---|--|
| PC-10-SG | 8436539306764 | oktober 175 -sharkgrey | 1 | 177 x 31.4 x 8.6 cm 69.7" x 12.4" x 3.4" | 0.04 m ³ 1.65 ft ³ | 10.60 kg 23.30 lb | Container 40': 1320 Container 40' HC: 1500 |



Sliding ring to lock the legs in position when in use. Easy and secure.

Argolla autodeslizante para bloquear las patas en posición de uso. Fácil y seguro.

Anneau autoglissant pour blocage des pieds en position d'usage. Facile et sûr.

Selbstgleitender Metallschiebering zur Feststellung der aufgeklappten Tischbeine. Einfach und sicher.

Capacity: 3 persons.
Area per person: 22.8".

Capacidad: 3 personas. Espacio por persona: 58 cm.

Capacité: 3 personnes.
Espace par personne: 58 cm.

Kapazität: 3 Personen. Platz pro Person: 58 cm.

One single top piece. With folding legs.

Sobre de una sola pieza. Patas plegables.

Surface d'une seule pièce. Pieds repliables.

Tischplatte aus einem Stück. Klappfüsse.

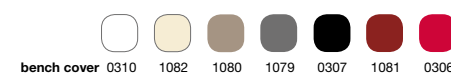
Multitrolley available for 30 benches. See page 92.

Carro Multitrolley disponible para 30 bancos. Ver página 92.

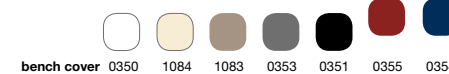
Chariot Multitrolley disponible pour 30 bancs. Voir page 92.

Wagen Multitrolley lieferbar für 30 Banken. Siehe S. 92.

stretch



plain



sharpbench180

new zown classic

SHARK
GREY

100%
PURE HDPE.
NOT MIXED



581-1
581-2 Contract
16139 L1



3
 400 kg / 882 lb
 24 hours (*)p. 31
 7.68 kg / 16.93 lb

 5 Limited 10 year warranty

| Code Código Code Code | EAN | Name Nombre Nom Name | Units per box Unidades por caja Unités par boîte Stückzahl pro Packung | Packaging size Medidas embalaje Dimensions emballage Verpackungsmaße | Packaging volume Volumen embalaje Volume d'emballage Verpackungsvolumen | Gross weight Peso bruto Poids brut Bruttogewicht | Loading quantity Unidades por contenedor por contenedor Unités par conteneur Einheiten pro Container |
|--------------------------------|---------------|-------------------------------|---|---|--|---|--|
| PC-15F-SG | 8436539306771 | sharpbench180 -shark grey | 1 | 95 x 33 x 11 cm 37.5" x 13" x 4.5" | 0.03 m ³ 1.11 ft ³ | 8.28 kg 18.25 lb | Container 40': 1720 Container 40' HC: 1960 |



Sliding ring to lock the legs in position when in use. Easy and secure.
Argolla autodeslizante para bloquear las patas en posición de uso. Fácil y seguro.
 Anneau autoglissant pour blocage des pieds en position d'usage. Facile et sûr.
Selbstgleitender Metallschiebering zur Feststellung der aufgeklappten Tischbeine. Einfach und sicher.

Bench provided with carrying handle for ease of transport.
Banco provisto de un asa para su fácil desplazamiento.
 Banc muni d'une anse pour déplacement facile.
Die Bank ist zur Vereinfachung des Transports mit einem Tragegriff für ausgestattet.

Bench with folding top.
Banco con sobre plegable.
 Banc avec surface pliable.
Bank mit zusammenklappbarer Sitzfläche.

Capacity: 3 persons. Area per person: 24".
Capacidad: 3 personas. Espacio por persona: 61 cm.
 Capacité: 3 personnes. Espace par personne: 61 cm.
Kapazität: 3 Personen. Platz pro Person: 61 cm.

Multitrolley available for 28 benches. See page 92.
Carro Multitrolley disponible para 28 bancos. Ver página 92.
 Chariot Multitrolley disponible pour 28 bancs. Voir page 92.
Wagen Multitrolley lieferbar für 28 Banken. Siehe S. 92.

stretch



- bench cover 0317 1088 1086 1085 0314 1087 0313

plain



- bench cover 0386 1090 1089 0389 0387 0391 0390

sharptable

new zown classic

SHARK
GREY

100%
PURE HDPE.
NOT MIXED



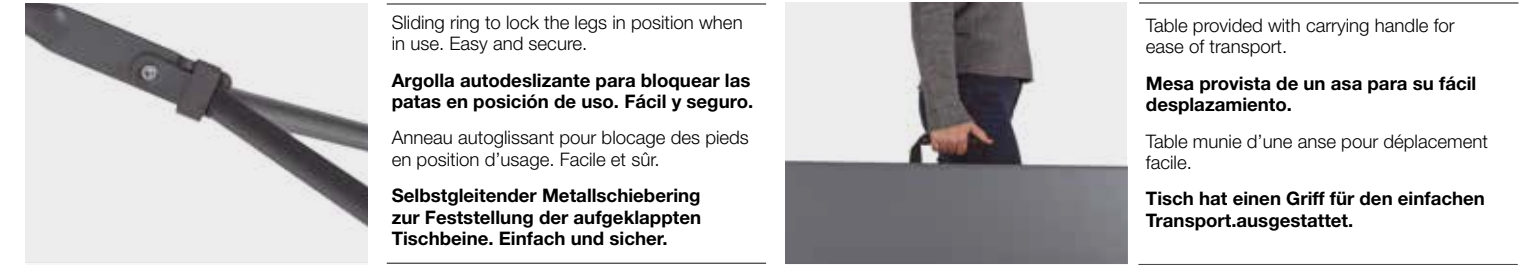
581-1
581-3 Contract
15372 L2



6
 315 kg / 694 lb
 24 hours (*)p. 31
 13.30 kg / 29.30 lb

 10 Limited 10 year warranty

| Code Código Code Code | EAN | Name Nombre Nom Name | Units per box Unidades por caja Unités par boîte Stückzahl pro Packung | Packaging size Medidas embalaje Dimensions emballage Verpackungsmaße | Packaging volume Volumen embalaje Volume d'emballage Verpackungsvolumen | Gross weight Peso bruto Poids brut Bruttogewicht | Loading quantity Unidades por contenedor por contenedor Unités par conteneur Einheiten pro Container |
|--------------------------------|---------------|--------------------------------|---|---|--|---|--|
| BT-06FG-NC | 8436539306597 | sharptable new zown classic | 1 | 77 x 95.5 x 10.5 cm 30.3" x 37.6" x 4.1" | 0.07 m ³ 2.71 ft ³ | 15.80 kg 34.76 lb | Container 40': 810 Container 40' HC: 910 |



Sliding ring to lock the legs in position when in use. Easy and secure.
Argolla autodeslizante para bloquear las patas en posición de uso. Fácil y seguro.
 Anneau autoglissant pour blocage des pieds en position d'usage. Facile et sûr.
Selbstgleitender Metallschiebering zur Feststellung der aufgeklappten Tischbeine. Einfach und sicher.

Table provided with carrying handle for ease of transport.
Mesa provista de un asa para su fácil desplazamiento.
 Table munie d'une anse pour déplacement facile.
Tisch hat einen Griff für den einfachen Transport.ausgestattet.

Folding table top.
Sobre plegable.
 Surface pliable.
Zusammenklappbare Tischplatte.

Capacity: 6 persons. Area per person: 24".
Capacidad: 6 personas. Espacio por persona: 61 cm.
 Capacité: 6 personnes. Espace par personne: 61 cm.
Kapazität: 6 Personen. Platz pro Person: 61 cm.

stretch



- table cover 0261 0876 0874 0873 0258 0875 0257
- top cover 0508 0880 0878 0877 0505 0879 0504

paramount



- table cover 0171 0884 0883 0174 0172 0176 0175
- tablecloth 0556

232 x 126 cm
91.3" x 49.6"

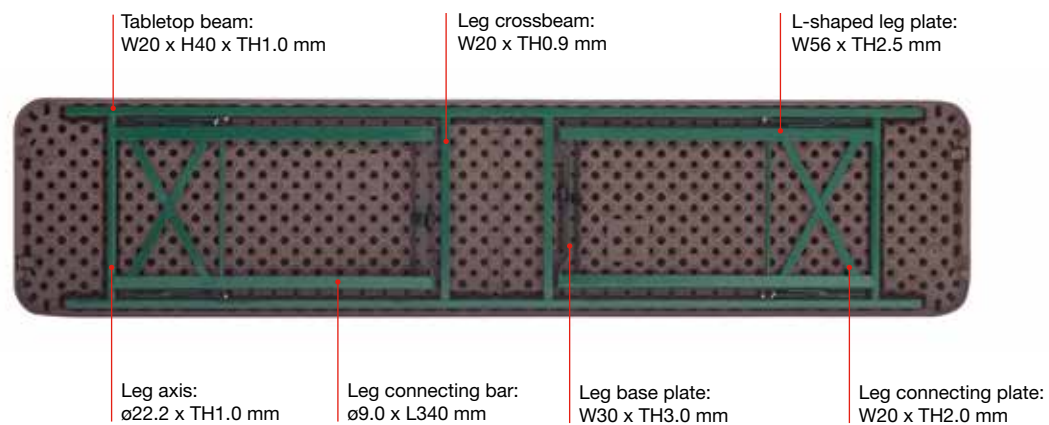
plain



- table cover 0404 0882 0881 0407 0405 0409 0408
- tablecloth 0556

232 x 126 cm
91.3" x 49.6"

munich50

100%
PURE HDPE.
NOT MIXED581-1
581-3 ContractH77 cm
H30.3"L220 x W50 cm
L86.6" x W19.6"Tabletop beam:
W20 x H40 x TH1.0 mmLeg crossbeam:
W20 x TH0.9 mmL-shaped leg plate:
W56 x TH2.5 mmLeg axis:
ø22.2 x TH1.0 mmLeg connecting bar:
ø9.0 x L340 mmLeg base plate:
W30 x TH3.0 mmLeg connecting plate:
W20 x TH2.0 mm

stretch



table cover 1158 1157 1155 1154 1159 1156 1160

bridge



table cover 1161 1167 1166 1163 1162 1165 1164



Longitudinal table joining system.

Sistema de unión longitudinal de mesas.

Système de raccord longitudinal de tables.

Vorrichtung zur längsseitigen Verbindung der Tische.

Base frame suitable for soft ground.

Base de apoyo apta para suelos blandos.

Base d'appui apte pour des sols meublés.

Beinrahmen für weiche Böden.

New and very smooth manual locking mechanism. Includes automatic sliding rings to prevent undesired folding.

Nuevo bloqueador manual de manejo muy suave. Incluye argollas autodeslizantes de seguridad para evitar el plegado involuntario.

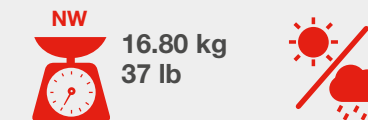
Nouveau mécanisme de blocage manuel au maniement très doux. Il inclut des anneaux autoglissant de sécurité pour éviter le pliage involontaire.

Neue, sehr leichtgängige, manuelle Verriegelung. Mit selbstgleitenden Sicherheitsringen, die ein unerwünschtes Zusammenklappen verhindern.

Base with anti-scratch polypropylene foot caps.

Base con tacos anti-rayas de polipropileno.

Base avec talons anti-rayures de polypropylène.

Mit integrierten Bodenschonern.Capacity: 8 persons.
Area per person: 21.7".**Capacidad: 8 personas.
Espacio por persona: 55 cm.**Capacité: 8 personnes.
Espace par personne: 55 cm.**Bietet Platz für 8 Personen.
Platz pro Person: 55 cm.**Multitrolley available for 13 benches.
See page 92.**Carro Multitrolley disponible para 13 bancos.
Ver página 92.**Chariot Multitrolley disponible pour 13 bancs.
Voir page 92.**Wagen Multitrolley lieferbar für 13 Banken.
Siehe S. 92.**Code
Código
Code
Code

PT004X002A

EAN 8436539299585

Name
Nombre
Nom
Name

munich50

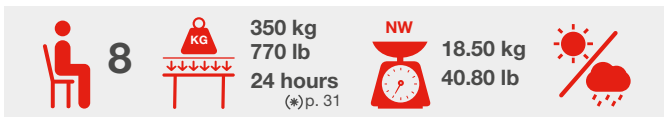
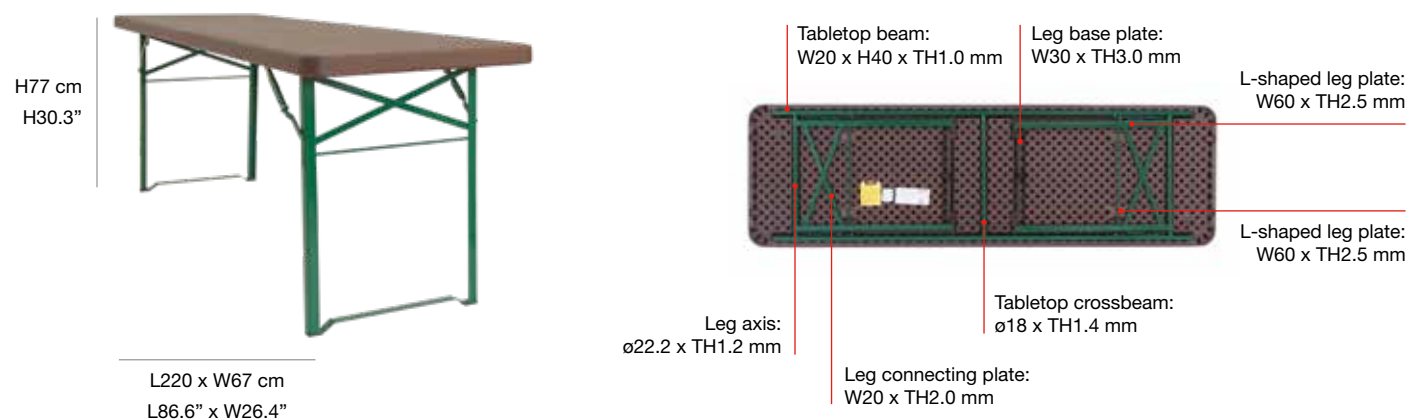
Units per box 1
Unidades por caja
Unités par boîte
Stückzahl pro PackungPackaging size 51.75 x 7 x 222.5 cm
Medidas embalaje 20.3" x 2.7" x 87.6"
Dimensions emballage
VerpackungsmaßePackaging volume 0.08 m³
Volumen embalaje 2.80 ft³
Volume d'emballage
VerpackungsvolumenGross weight 18.30 kg
Peso bruto 40.34 lb
Poids brut
BruttogewichtLoading quantity Container 40': 760
Unidades por contenedor Container 40' HC: 850
Unités par conteneur
Einheiten
pro Container

munich70

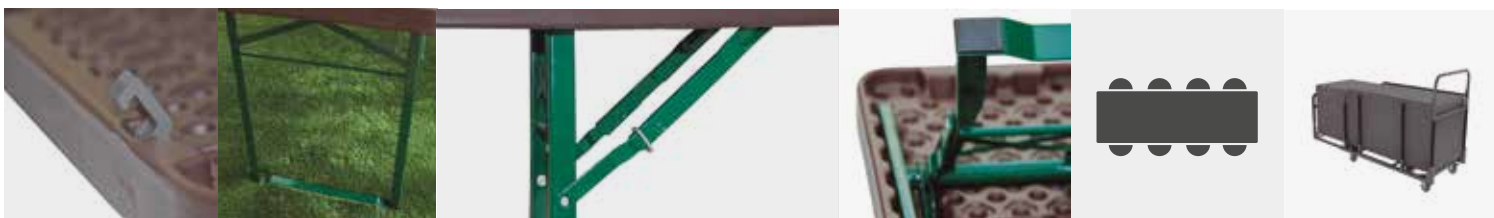
100%
PURE HDPE.
NOT MIXED



581-1
581-3 Contract



| Code Código Code Code | EAN | Name Nombre Nom Name | Units per box Unidades por caja Unités par boîte Stückzahl pro Packung | Packaging size Medidas embalaje Dimensions emballage Verpackungsmaße | Packaging volume Volumen embalaje Volume d'emballage Verpackungsvolumen | Gross weight Peso bruto Poids brut Bruttogewicht | Loading quantity Unidades por contenedor Unités par conteneur Einheiten pro Container |
|--------------------------------|---------------|-------------------------------|---|---|--|---|--|
| PT-46 | 8436539290285 | munich70 | 1 | 222 x 69 x 7 cm 87.6" x 27.1" x 2.7" | 0.10 m ³ 3.77 ft ³ | 20.76 kg 45.76 lb | Container 40': 570 Container 40' HC: 645 |



Longitudinal table joining system.
Sistema de unión longitudinal de mesas.
Système de raccord longitudinal de tables.
Vorrichtung zur längsseitigen Verbindung der Tische.

Base frame suitable for soft ground.
Base de apoyo apta para suelos blandos.
Base d'appui apte pour des sols meublés.
Beinrahmen für weiche Böden.

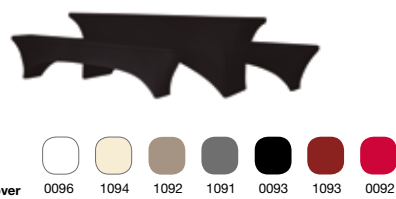
New and very smooth manual locking mechanism. Includes automatic sliding rings to prevent undesired folding.
Nuevo bloqueador manual de manejo muy suave. Incluye argollas autodeslizantes de seguridad para evitar el plegado involuntario.
Nouveau mécanisme de blocage manuel au maniement très doux. Il inclut des anneaux autoglossants de sécurité pour éviter le pliage involontaire.
Neue, sehr leichtgängige, manuelle Verriegelung. Mit selbstgleitenden Sicherheitsringen, die ein unerwünschtes Zusammenklappen verhindern.

Base with anti-scratch polypropylene foot caps.
Base con tacos anti-rayas de polipropileno.
Base avec talons anti-rayures de polypropylène.
Mit integrierten Bodenschonern.

Capacity: 8 persons.
Area per person: 21.7".
Capacidad: 8 personas. Espacio por persona: 55 cm.
Capacité: 8 personnes.
Espace par personne: 55 cm.
Bietet Platz für 8 Personen. Platz pro Person: 55 cm.

Multitrolley available for 13 tables.
See page 92.
Carro Multitrolley disponible para 13 mesas. Ver página 92.
Chariot Multitrolley disponible pour 13 tables.
Voir page 92.
Wagen Multitrolley lieferbar für 13 Tische. Siehe S. 92.

strech



set cover 0096 1094 1092 1091 0093 1093 0092

bridge



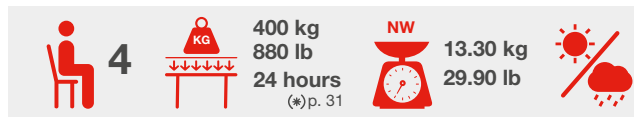
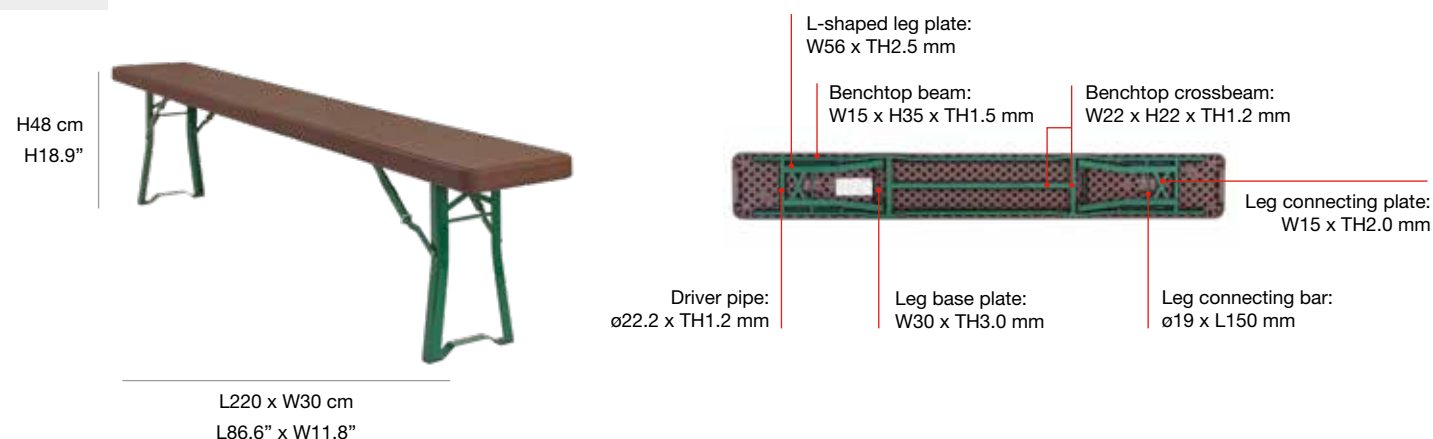
set cover 0099 1096 1095 0102 0100 0104 0103

munichbench

100%
PURE HDPE.
NOT MIXED



581-1
581-2 Contract



| Code Código Code Code | EAN | Name Nombre Nom Name | Units per box Unidades por caja Unités par boîte Stückzahl pro Packung | Packaging size Medidas embalaje Dimensions emballage Verpackungsmaße | Packaging volume Volumen embalaje Volume d'emballage Verpackungsvolumen | Gross weight Peso bruto Poids brut Bruttogewicht | Loading quantity Unidades por contenedor Unités par conteneur Einheiten pro Container |
|--------------------------------|---------------|-------------------------------|---|---|--|---|--|
| PC-27 | 8436539290278 | munichbench | 1 | 222 x 32 x 6.9 cm 87.6" x 12.6" x 2.7" | 0.04 m ³ 1.73 ft ³ | 15.20 kg 33.44 lb | Container 40': 1221 Container 40' HC: 1396 |

Base frame suitable for soft ground.
Base de apoyo apta para suelos blandos.
Base d'appui apte pour des sols meublés.
Beinrahmen für weiche Böden.

New and very smooth manual locking mechanism. Includes automatic sliding rings to prevent undesired folding.
Nuevo bloqueador manual de manejo muy suave. Incluye argollas autodeslizantes de seguridad para evitar el plegado involuntario.
Nouveau mécanisme de blocage manuel au maniement très doux. Il inclut des anneaux autoglossants de sécurité pour éviter le pliage involontaire.
Neue, sehr leichtgängige, manuelle Verriegelung. Mit selbstgleitenden Sicherheitsringen, die ein unerwünschtes Zusammenklappen verhindern.

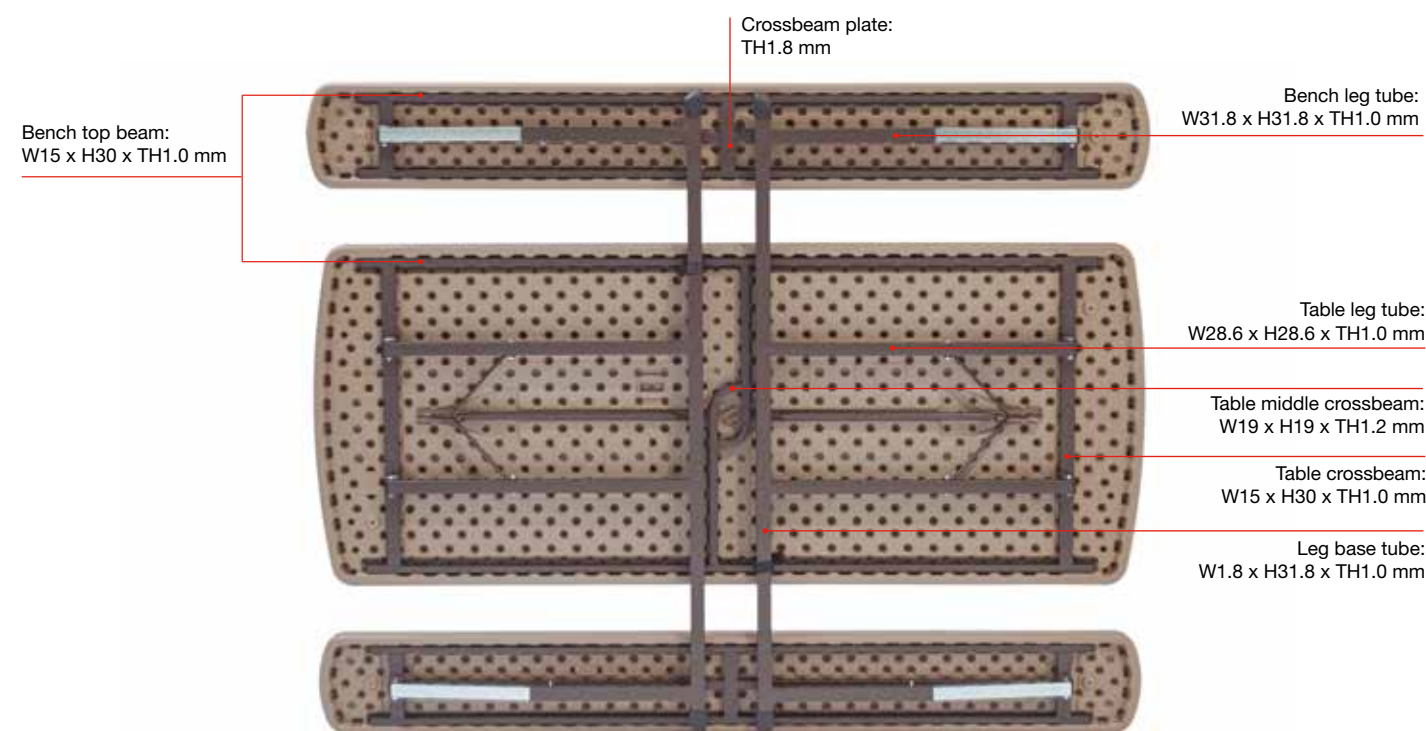
Base with anti-scratch polypropylene foot caps.
Base con tacos anti-rayas de polipropileno.
Base avec talons anti-rayures de polypropylène.
Mit integrierten Bodenschonern.

Capacity: 4 persons.
Area per person: 21.7".
Capacidad: 4 personas. Espacio por persona: 55 cm.
Capacité: 4 personnes.
Espace par personne: 55 cm.
Bietet Platz für 4 Personen. Platz pro Person: 55 cm.

Multitrolley available for 28 benches.
See page 92.
Carro Multitrolley disponible para 28 bancos. Ver página 92.
Chariot Multitrolley disponible pour 28 bancs.
Voir page 92.
Wagen Multitrolley lieferbar für 28 Banken. Siehe S. 92.

dakotapicnicset

NEW

100%
PURE HDPE.
NOT MIXED581-1
581-3 Contract

Polyethylene table and seats with textured wood effect.
Camel brown colour.

**Mesa y asientos de polietileno con texturizado efecto madera.
Color marrón camel.**

Table et chaises en polyéthylène avec texturisation effet bois.
Couleur marron camel.

**Tisch und Sitzflächen aus Polyethylen mit holzähnlicher Textur
Farbe Kamelbraun.**

Central hole (5.2 cm Ø) available for the placement of a parasol.

**Orificio central (5.2 cm Ø) disponible para la colocación de un
parasol.**

Orifice central (5.2 cm Ø) disponible pour le placement d'un parasol.

**Öffnung in der Mitte (5.2 cm Ø) zum Aufstellen eines
Sonnenschirms.**

Sliding ring to lock the legs in position when in use. Easy and secure.

**Argolla autodeslizante para bloquear las patas en posición de
uso. Fácil y seguro.**

Anneau autoglissant pour blocage des pieds en position d'usage.
Facile et sûr.

**Selbstgleitender Metallschiebering zur Feststellung der
aufgeklappten Tischbeine. Einfach und sicher.**

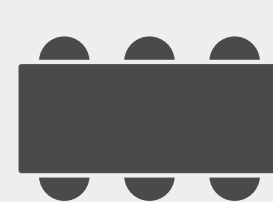


Folding set with integrated benches.

Set plegable con bancos integrados.

Set pliable avec bancs intégrés.

Klappbares Set mit integrierten Bänken.

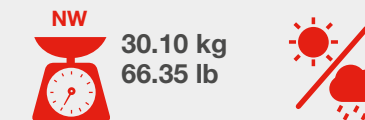


Capacity: 6 persons.
Area per person: 24".

**Capacidad: 6 personas.
Espacio por persona: 61 cm.**

Capacité: 6 personnes.
Espace par personne: 61 cm.

**Bietet Platz für 6 Personen.
Platz pro Person: 61 cm.**



Code PT046X001A
Código
Code
Code

EAN 8436539309659

Name dakotapicnicset
Nombre
Nom
Name

Units per box 1
Unidades por caja
Unités par boîte
Stückzahl pro Packung

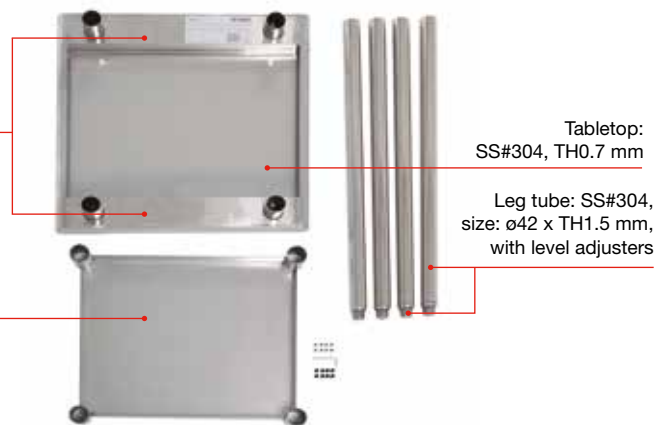
Packaging size 186 x 77.5 x 13.30 cm
Medidas embalaje L73.22" x 30.5" x 5.23"
Dimensions emballage
Verpackungsmaße

Packaging volume 0.19 m³
Volumen embalaje 6.77 ft³
Volume d'emballage
Verpackungsvolumen

Gross weight 35 kg
Peso bruto 77.16 lb
Poids brut
Bruttogewicht

Loading quantity Container 40': 306
Unidades por contenedor Container 40' HC: 345
Unités par conteneur
Einheiten
pro Container

SS60

100%
STAINLESS
STEEL SS304L61 x W61 cm
L24" x W24"Tabletop beam plate:
SS#304, TH0.7 mmShelf plate:
SS#304, TH0.7 mmTabletop:
SS#304, TH0.7 mmLeg tube: SS#304,
size: ø42 x TH1.5 mm,
with level adjusters

| Code Código Code | EAN | Name Nombre Nom Name | Units per box Unidades por caja Unités par boîte Stückzahl pro Packung | Packaging size Medidas embalaje Dimensions emballage Verpackungsmaße | Packaging volume Volumen embalaje Volume d'emballage Verpackungsvolumen | Gross weight Peso bruto Poids brut Bruttogewicht | Loading quantity Unidades Unités par conteneur Einheiten pro Container |
|------------------------|---------------|-------------------------------|---|--|--|---|--|
| OT002X001 | 8436539296485 | SS60 table | Carton A Carton B | 62.9 x 64.5 x 12.4 cm 24.7" x 25.4" x 4.9" 19 x 5.7 x 89 cm 7.5" x 2.3" x 35" | 0.12 m3 4.23 ft3 | 13.40 kg 29.54 lb | Container 40': 760 Container 40' HC: 876 |
| 107DG006A004A | 8436539296492 | SSwheels set | 1 | 20 x 20 x 20 cm 7.9" x 7.9" x 7.9" | 0.01 m3 0.28 ft3 | | Container 40': 4300 Container 40' HC: 8700 |



Set of four wheels available (two of which have a built-in brake). By adding the wheels, it can also serve the function of a "mobile work table" or "trolley".

Set de cuatro ruedas disponible (dos de ellas con freno incorporado). Al incorporar las ruedas, puede cumplir también la función de "mesa de trabajo móvil" o de "carro."

Set de quatre roues disponible (deux d'entre elles avec frein incorporé). L'incorporation des quatre roues permet d'assurer aussi la fonction de "table de travail mobile" ou de "chariot".

Räder-Set mit vier Rädern lieferbar (zwei davon mit eingebauter Bremse). Durch den Einbau der Räder kann der Tisch auch als "fahrbarer Arbeitstisch" oder "Wagen" eingesetzt werden.

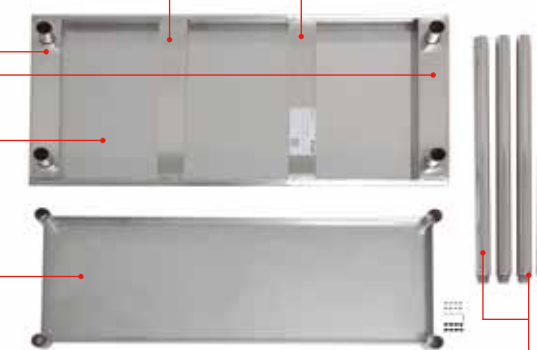
Height adjuster on the 4 legs.

Regulador de altura en las 4 patas.

Niveau réglable des 4 pieds.

Integrierte Höhenverstellung an den 4 Tischbeinen.

SS120

100%
STAINLESS
STEEL SS304L122 x W61cm
L48" x W24"Tabletop beam plate:
SS#304, TH0.7 mm x W161.5 mmTabletop plate:
SS#304, TH1.0 mm x W717 mmShelf plate:
SS#304, TH1.0 mm x W526.2 mmTabletop beam plate:
SS#304, TH1.0 mm x W171 mmLegs: SS#304,
size: ø42 x TH1.5 mm,
with level adjusters

| Code Código Code | EAN | Name Nombre Nom Name | Units per box Unidades por caja Unités par boîte Stückzahl pro Packung | Packaging size Medidas embalaje Dimensions emballage Verpackungsmaße | Packaging volume Volumen embalaje Volume d'emballage Verpackungsvolumen | Gross weight Peso bruto Poids brut Bruttogewicht | Loading quantity Unidades Unités par conteneur Einheiten pro Container |
|------------------------|---------------|-------------------------------|---|---|--|---|--|
| OT001X001 | 8436539296416 | SS120 table | 1 | 128.3 x 67.3 x 14 cm 50.5" x 26.5" x 5.5" | 0.120 m3 4.237 ft3 | 21.55 kg 47.50 lb | Container 40': 575 Container 40' HC: 651 |
| 107DG006A004A | 8436539296492 | SSwheels set | 1 | 20 x 20 x 20 cm 7.9" x 7.9" x 7.9" | 0.008 m3 0.282 ft3 | | Container 40': 4300 Container 40' HC: 8700 |



Set of four wheels available (two of which have a built-in brake). By adding the wheels, it can also serve the function of a "mobile work table" or "trolley".

Set de cuatro ruedas disponible (dos de ellas con freno incorporado). Al incorporar las ruedas, puede cumplir también la función de "mesa de trabajo móvil" o de "carro."

Set de quatre roues disponible (deux d'entre elles avec frein incorporé). L'incorporation des quatre roues permet d'assurer aussi la fonction de "table de travail mobile" ou de "chariot".

Räder-Set mit vier Rädern lieferbar (zwei davon mit eingebauter Bremse). Durch den Einbau der Räder kann der Tisch auch als "fahrbarer Arbeitstisch" oder "Wagen" eingesetzt werden.

Height adjuster on the 4 legs.

Regulador de altura en las 4 patas.

Niveau réglable des 4 pieds.

Integrierte Höhenverstellung an den 4 Tischbeinen.

alexchairNC

SHARK
GREY

100%
PP



581-1
581-2 Contract



| Code Código Code | EAN | Name Nombre Nom Name | Units per box Unidades por caja Unités par boîte Stückzahl pro Packung | Packaging size Medidas embalaje Dimensions emballage Verpackungsmaße | Packaging volume Volumen embalaje Volume d'emballage Verpackungsvolumen | Gross weight Peso bruto Poids brut Bruttogewicht | Loading quantity Unidades por contenedor Unités par conteneur Einheiten pro Container |
|------------------------|---------------|-------------------------------|--|---|--|---|--|
| IC001X015A-SG | 8436539310501 | alexchairsharkgrey | 8 | 46 x 26.3 x 101 cm | 0.12 m3 | 30.65 kg | Container 40': 3984 |
| IC001X015A-BB | 8436539310525 | alexchairblack | | 18.12" x 10.4" x 39.87" | 4.23 ft3 | 67.57 lb | Container 40' HC: 4800 |
| IC001X015A-WW | 8436539310518 | alexchairwhite | | | | | |



Front leg caps especially designed to guarantee safe and stable stackability.

Taco de las patas frontales diseñado especialmente para garantizar una apilabilidad segura y estable.

Taquet des pieds frontaux spécialement conçu pour garantir un empilage sûr et stable.

Klotz der Vorderbeine mit speziellem Design zur Gewährleistung einer sicheren und stabilen Stapelbarkeit.

Alextrolley available for 60 chairs. See page 122.

Alextrolley disponible para 60 sillas. Ver pág. 122.

Alextrolley disponible pour 60 chaises. Voir page 122.

Wagen alextrolley lieferbar für 60 Stühle. Siehe S. 122.



PP Shark Grey
POWDER-COATED
STEEL
Shark Grey

PP Black
POWDER-COATED
STEEL
Black

PP White
POWDER-COATED
STEEL
White

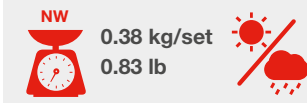
mega-connector for alexchair

NEW

100%
PURE HDPE.
NOT MIXED



14703



| Code Código Code | EAN | Name Nombre Nom Name | Units per box Unidades por caja Unités par boîte Stückzahl pro Packung | Packaging size Medidas embalaje Dimensions emballage Verpackungsmaße | Packaging volume Volumen embalaje Volume d'emballage Verpackungsvolumen | Gross weight Peso bruto Poids brut Bruttogewicht |
|------------------------|---------------|-------------------------------|--|---|--|---|
| RA078X001A-H | 8436539309468 | mega-connector for alexchair | 20 | 45 x 24.4 x 22.86 cm 17.75" x 9.62" x 9" | 0.03 m3 0.89 ft3 | 8.5 kg (20 sets) 18.74 lb |



Set of three pieces (rear, front and centre) to connect the Alex chairs.

Set de 3 piezas (trasera, frontal y central) para conectar las sillas Alex.

Set de 3 pièces (arrière, frontale et centrale) pour assembler les chaises Alex.

3-teiliges Set (Hinterteil, Vorderteil und Mittelteil) zur Verbindung der Alex-Stühle.

Each box of 20 sets includes a hammer with soft ends to facilitate part placement.

Cada caja de 20 sets incluye un martillo con extremos blandos para facilitar la colocación de las piezas.

Chaque boîte de 20 sets comprend un marteau avec des extrémités molles pour faciliter le placement des pièces.

Jeder Karton zu 20 Sets enthält einen Gummihammer zum leichteren Anbringen der Teile.

Compliance with the anti-panic European standard EN 14703.

Cumple con la normativa europea antipánico EN 14703.

Respecte la norme européenne antipanique EN 14703.

Erfüllt die Anforderungen der europäischen Sicherheitsnormb EN 14703.

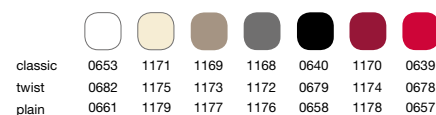
stretch



classic



sashes



bigalexchair

SHARK GREY

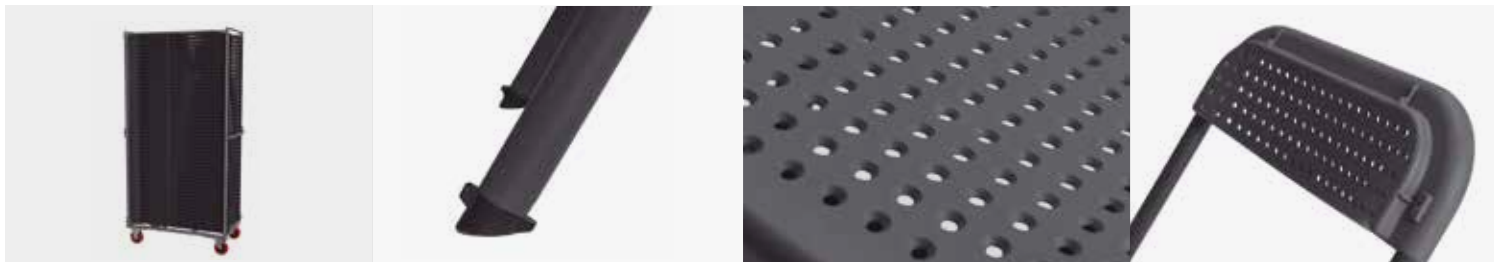
100%
PP



581-1
581-2 Contract
16139 L1



| Code Código Code | EAN | Name Nombre Nom Name | Units per box Unidades por caja Unités par boîte Stückzahl pro Packung | Packaging size Medidas embalaje Dimensions emballage Verpackungsmaße | Packaging volume Volumen embalaje Volume d'emballage Verpackungsvolumen | Gross weight Peso bruto Poids brut Bruttogewicht | Loading quantity Unidades por contenedor Unités par conteneur Einheiten pro Container |
|------------------------|---------------|-------------------------------|---|---|--|---|--|
| IC008X001A-SG | 8436539306825 | bigalexchairsharkgrey | 4 | L52.7 x W16.82 x H101.6 cm | 0.09 m3 | 17.20 kg | Container 40': 2576 |
| IC008X001A-WW | 8436539299554 | bigalexchairwhite | 4 | L20.75" x W6.625" x H40" | 3.17 ft3 | 37.88 lb | Container 40' HC: 2980 |
| IC008X001A-BB | 8436539304517 | bigalexchairblack | 4 | | | | |



Bigalexrolley available for:
H1683mm: 43 pcs. H1960mm: 51 pcs.
See page 119.

Bigalexrolley disponible para:
H1683mm: 43u. H1960mm: 51u.
Ver pág. 119.

Bigalexrolley disponible pour 50 chaises.
H1683mm: 43u. H1960mm: 51u.
Voir page 119.

Wagen bigalexrolley lieferbar für
H1683mm: 43 Stk. H1960mm: 51 Stk.
Siehe S. 119.

Front leg caps especially designed to guarantee safe and stable stackability.

Taco de las patas frontales diseñado especialmente para garantizar una apilabilidad segura y estable.

Taquet des pieds frontaux spécialement conçu pour garantir un empilage sûr et stable.

Klotz der Vorderbeine mit speziellem Design zur Gewährleistung einer sicheren und stabilen Stapelbarkeit.

The perforated top gives breathability to the seat and back. It also facilitates drainage in case of rain.

La superficie perforada confiere transpirabilidad al asiento y respaldo. También facilita el drenaje en caso lluvia.

La surface perforée rend transpirable le siège et le dossier. Elle facilite également le drainage en cas de pluie.

Die gelochte Oberfläche von Sitz und Rückenlehne gewährleistet eine optimale Ventilation. Darüber hinaus erleichtert sie den Wasserablauf bei Niederschlag.

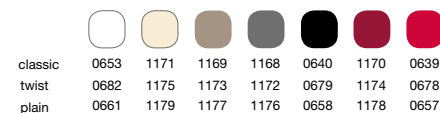
stretch



classic



sashes



bigalexrolley

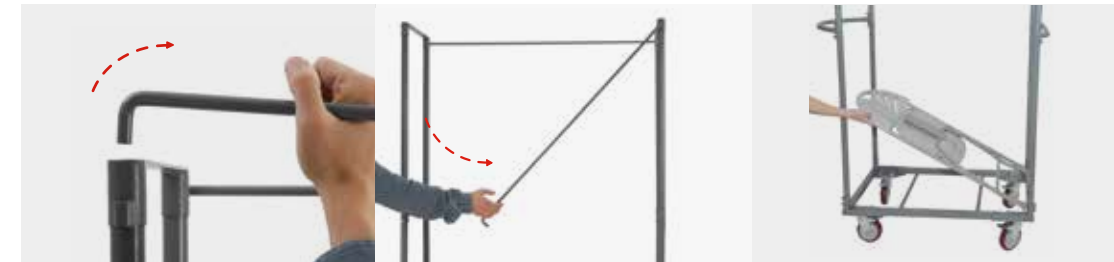
100%
POWDER
COATED
STEEL



16121 L2



| Code Código Code | EAN | Name Nombre Nom Name | Units per box Unidades por caja Unités par boîte Stückzahl pro Packung | Packaging size Medidas embalaje Dimensions emballage Verpackungsmaße | Packaging volume Volumen embalaje Volume d'emballage Verpackungsvolumen | Gross weight Peso bruto Poids brut Bruttogewicht | Loading quantity Unidades por contenedor Unités par conteneur Einheiten pro Container |
|------------------------|---------------|-------------------------------|---|---|--|---|--|
| RA-CB030F001 | 8436539306245 | bigalexrolley | 1 | L103.18 x W59.4 x H12 cm L40.62" x W23.37" x H4.75" | 0.07 m3 2.59 ft3 | 20 kg 44 lb | Container 40' HC: 840 |



Easy locking and unlocking of the vertical posts. Ease of access for loading and unloading.

Fácil bloqueo y desbloqueo de los postes verticales. Cómodo acceso para cargar o descargar.

Poteaux verticaux faciles à bloquer et débloquer. Accès pratique pour chargement ou déchargement.

Leichtes Blockieren und Entriegeln der senkrechten Stangen. Bequemer Zugriff zum Ein- oder Ausladen.



Vertical posts to hold the stacked chairs in place.

Postes verticales para inmovilizar las sillas apiladas.

Poteaux verticaux pour immobilisation des chaises empilées.

Senkrechte Stangen geben den gestapelten Stühlen Halt.



Four polyurethane wheels with built-in brake. (Two fixed wheels and two pivoting wheels).

4 ruedas de poliuretano con freno incorporado (2 ruedas fijas y 2 ruedas pivotantes).

4 roues en polyuréthane avec frein intégré. (2 roues fixes et 2 roues pivotantes).

4 PU-Räder mit integrierter Bremse. (2 feststehende Räder und 2 Schwenkräder).



Capacity (H1683mm): 43 pcs. bigalexchair.
Capacity (H1960mm): 51 pcs. bigalexchair.

**Capacidad (H1683mm): 43u. bigalexchair.
Capacidad (H1960mm): 51u. bigalexchair.**

Capacité (H1683mm): 43u. bigalexchair.
Capacité (H1960mm): 51u. bigalexchair.

**Fassungsvermögen (H1683mm): 43 Stk. bigalexchair.
Fassungsvermögen (H1960mm): 51 Stk. bigalexchair.**



alex**trolley**

100%

POWDER
COATED
STEEL

16121 L2

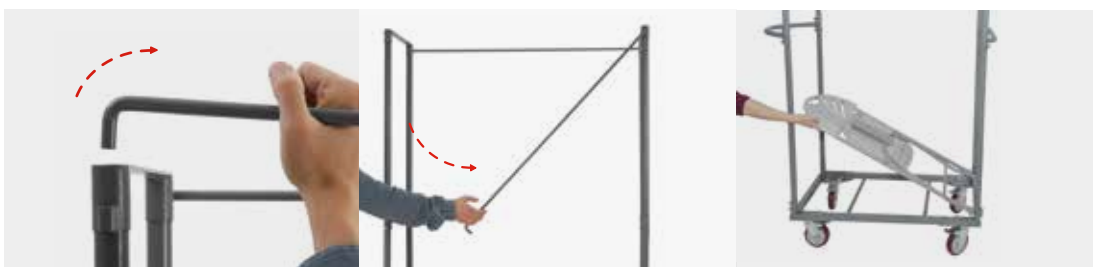
H196.8 cm
H77.5"

L95.4 x W47.5 cm

L37.5" x W18.7"

19.40 kg
41.90 lb

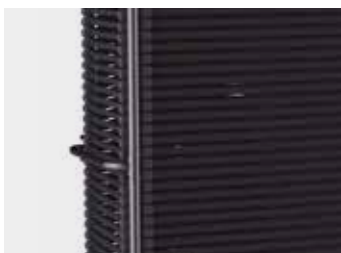
| Code Código Code Code | EAN | Name Nombre Nom Name | Units per box Unidades por caja Unités par boîte Stückzahl pro Packung | Packaging size Medidas embalaje Dimensions emballage Verpackungsmaße | Packaging volume Volumen embalaje Volume d'emballage Verpackungsvolumen | Gross weight Peso bruto Poids brut Bruttogewicht | Loading quantity Unidades por contenedor Unités par conteneur Einheiten pro Container |
|--------------------------------|---------------|-------------------------------|---|---|--|---|--|
| RA-104A | 8437009886137 | alex trolley | 1 | 102.1 x 54.8 x 12 cm 40.2" x 21.6" x 4.7" | 0.06 m3 2.40 ft3 | 21.20 kg 46.60 lb | Container 40': 910 Container 40' HC: 1010 |



Easy locking and unlocking of the vertical posts. Ease of access for loading and unloading.

Fácil bloqueo y desbloqueo de los postes verticales. Cómodo acceso para cargar o descargar.

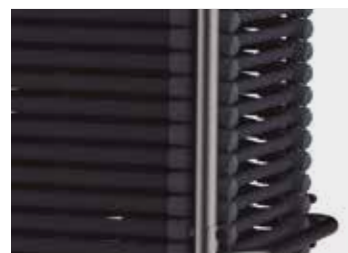
Poteaux verticaux faciles à bloquer et débloquer. Accès pratique pour chargement ou déchargement.

Leichtes Blockieren und Entriegeln der senkrechten Stangen. Bequemer Zugriff zum Ein- oder Ausladen.

Handle specially designed to protect the hands and to occupy a minimum of space.

Asa diseñada para proteger las manos y ocupar el mínimo espacio.

Anse spécialement conçue pour protéger les mains et occuper un espace minime.

Besonders geformter Griff zum Schutz der Hände und platzsparend.

Vertical posts to hold the stacked chairs in place.

Postes verticales para inmovilizar las sillas apiladas.

Poteaux verticaux pour immobilisation des chaises empilées.

Senkrechte Stangen geben den gestapelten Stühlen Halt.

Four polyurethane wheels with built-in brake. (Two fixed wheels and two pivoting wheels).

4 ruedas de poliuretano con freno incorporado (2 ruedas fijas y 2 ruedas pivotantes).

4 roues en polyuréthane avec frein intégré. (2 roues fixes et 2 roues pivotantes).

4 PU-Räder mit integrierter Bremse. (2 feststehende Räder und 2 Schwenkräder).

Capacity: 60 pcs. alex or alex-k chairs.

Capacidad: 60u. Sillas alex o alex-k.

Capacité: 60u. Chaises alex ou alex-k.

Fassungsvermögen: 60 Stk. Stühle alex oder alex-k.

olafchair

100%
PP

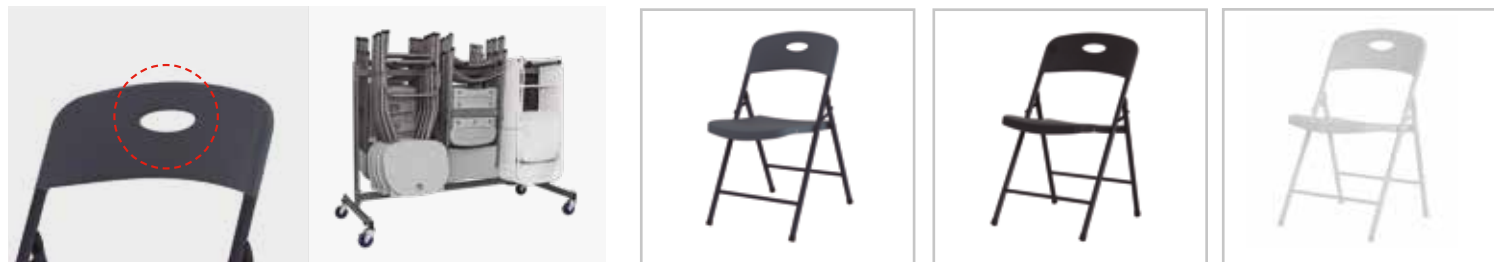


581-1
581-2 Contract
16139 L1

NEW



| Code Código Code Code | EAN | Name Nombre Nom Name | Units per box Unidades por caja Unités par boîte Stückzahl pro Packung | Packaging size Medidas embalaje Dimensions emballage Verpackungsmaße | Packaging volume Volumen embalaje Volume d'emballage Verpackungsvolumen | Gross weight Peso bruto Poids brut Bruttogewicht | Loading quantity Unidades por contenedor Unités par conteneur Einheiten pro Container |
|--------------------------------|---------------|-------------------------------|---|---|--|---|--|
| IC004X003A-SG | 8436539309673 | olafchair-sharkgrey | 4 | 47.92 x 20.95 x 99.36 cm 18.87" x 8.25" x 39.12" | 0.10 m ³ 3.52 ft ³ | 14.50 kg 31.96 lb | Container 40': 2460 Container 40' HC: 2740 |
| IC004X003A-BB | 8436539296515 | olafchair-black | | | | | |
| IC004X003A-WW | 8436539296522 | olafchair-white | | | | | |



Handle for easy manoeuvring of the chair.

Asa para facilitar el manejo y desplazamiento de la silla.

Anse pour faciliter le maniement et le déplacement de la chaise.

Griff zum leichteren Handhaben und Bewegen des Stuhls.

Liam Trolley available for 36 chairs. See page 135.

Liam Trolley disponible para 36 sillas. Ver página: 135.

Liam Trolley disponible pour 36 chaises. Voir page 135.

Liam-Trolley für 36 Stühle. Siehe Seite: 135.



stretch

classic

sashes



classic 0653 1171 1169 1168 0640 1170 0639
twist 0682 1175 1173 1172 0679 1174 0678
plain 0661 1179 1177 1176 0658 1178 0657

olafskidchair

100%
PP

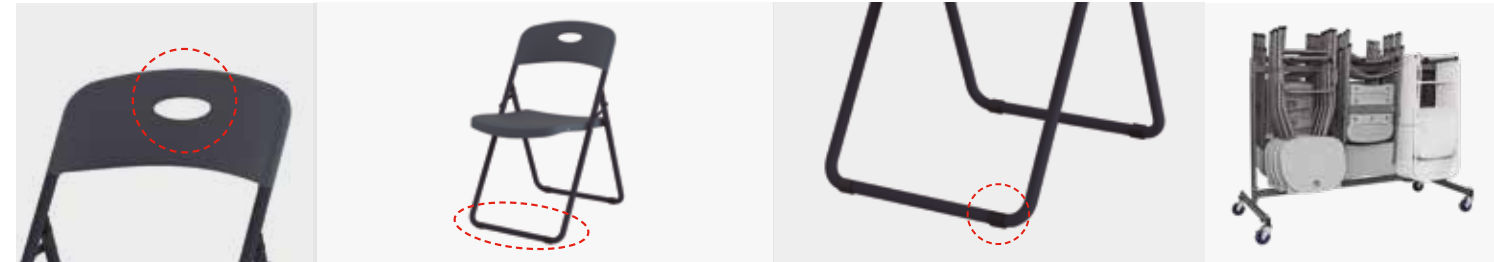
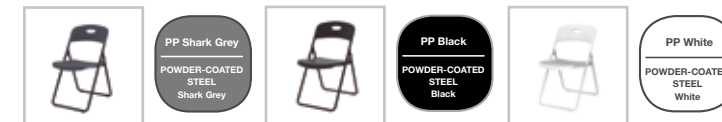


581-1
581-2 Contract
16139 L1

NEW



| Code Código Code Code | EAN | Name Nombre Nom Name | Units per box Unidades por caja Unités par boîte Stückzahl pro Packung | Packaging size Medidas embalaje Dimensions emballage Verpackungsmaße | Packaging volume Volumen embalaje Volume d'emballage Verpackungsvolumen | Gross weight Peso bruto Poids brut Bruttogewicht | Loading quantity Unidades por contenedor Unités par conteneur Einheiten pro Container |
|--------------------------------|---------------|-------------------------------|---|---|--|---|--|
| IC004X004A-SG | 8436539309680 | olafskidchair-sharkgrey | 4 | 47.75 x 20.95 x 99.36 cm 18.80" x 8.25" x 39.12" | 0.10 m ³ 3.51 ft ³ | 16.38 kg 36.11 lb | Container 40': 2460 Container 40' HC: 2740 |
| IC004X004A-BB | 8436539309703 | olafskidchair-black | | | | | |
| IC004X004A-WW | 8436539309697 | olafskidchair-white | | | | | |



Handle for easy manoeuvring of the chair.

Asa para facilitar el manejo y desplazamiento de la silla.

Anse pour faciliter le maniement et le déplacement de la chaise.

Griff zum leichteren Handhaben und Bewegen des Stuhls.

Sled base frame especially apt for soft ground like grass.

Estructura de pie-patin especialmente indicada para suelos blandos como el césped.

Structure de pied-patin particulièrement indiquée pour des sols mous comme le pelouse.

Kufenförmiges Beingestell, ideal für weiche Böden wie Rasen.

Sled base with anti-scratch polypropylene piece for delicate floors.

Pie-patin con pieza de polipropileno anti-rayas para suelos delicados.

Pied-patin avec pièce en polypropylène anti-rayures pour de sols délicats.

Kufenförmiges Beingestell mit Kratzschutzteil aus Polypropylen für heikle Böden.

Liam Trolley available for 36 chairs. See page 135.

Liam Trolley disponible para 36 sillas. Ver página: 135.

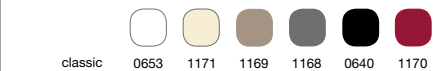
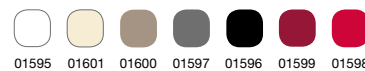
Liam Trolley disponible pour 36 chaises. Voir page 135.

Liam-Trolley für 36 Stühle. Siehe Seite: 135.

stretch

classic

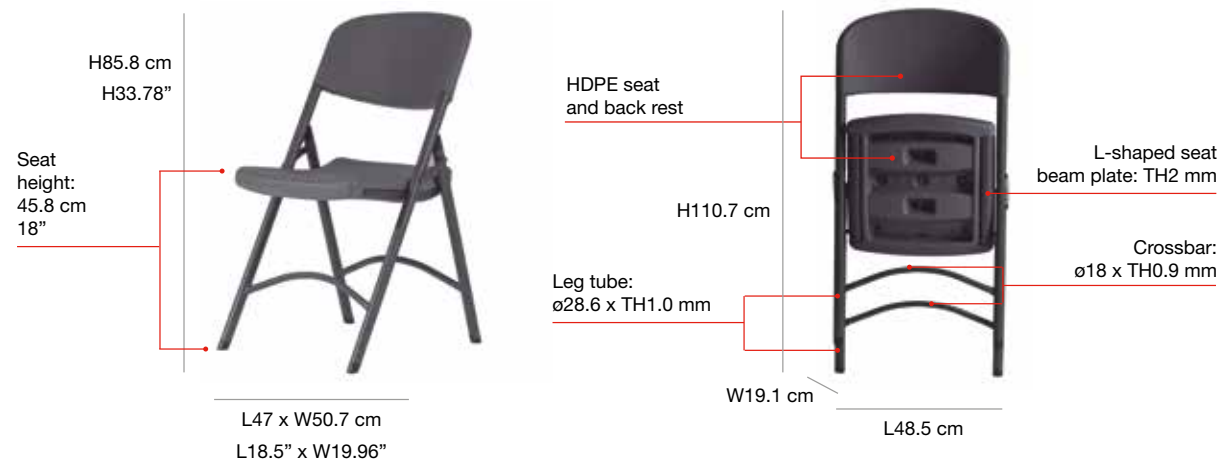
sashes



classic 0653 1171 1169 1168 0640 1170 0639
twist 0682 1175 1173 1172 0679 1174 0678
plain 0661 1179 1177 1176 0658 1178 0657

norman**chair**

SHARK
GREY



100%
PURE HDPE.
NOT MIXED



581-1
581-2 Contract
16139 L1

100%
POWDER
COATED
STEEL



16121 L2

norman**trolley**



L110 x W48 cm
L43.3" x W18.9"

KG 272 kg / 600 lb
24 hours
(*) p. 31

NW 5.25 kg / 11.57 lb

5 Limited 5 year warranty



NW 20.1 kg / 43.8 lb

| Code Código Code | EAN | Name Nombre Nom Name | Units per box Unidades por caja Unités par boîte Stückzahl pro Packung | Packaging size Medidas embalaje Dimensions emballage Verpackungsmaße | Packaging volume Volumen embalaje Volume d'emballage Verpackungsvolumen | Gross weight Peso bruto Poids brut Bruttogewicht | Loading quantity Unidades por contenedor por contenedor Unités par conteneur Einheiten pro Container |
|------------------------|--------------------------------|--|---|---|--|---|--|
| PC-23-SG RA-115 | 8436539306900 8437009886304 | norman chair -sharkgrey ottolink | 4 | 48.6 x 31.7 x 114.3 cm 19.1" x 12.5" x 45" | 0.17 m ³ 6.21 ft ³ | 23.04 kg 50.76 lb | Container 40': 1336 Container 40' HC: 1536 |

| Code Código Code | EAN | Name Nombre Nom Name | Units per box Unidades por caja Unités par boîte Stückzahl pro Packung | Packaging size Medidas embalaje Dimensions emballage Verpackungsmaße | Packaging volume Volumen embalaje Volume d'emballage Verpackungsvolumen | Gross weight Peso bruto Poids brut Bruttogewicht | Loading quantity Unidades por contenedor por contenedor Unités par conteneur Einheiten pro Container |
|------------------------|---------------|-------------------------------|---|---|--|---|--|
| RA-103-01 | 8437009886786 | norman trolley | 1 | 117.5 x 51.4 x 12 cm 46.2" x 20.2" x 4.7" | 0.07 m ³ 2.54 ft ³ | 22.2 kg 48.8 lb | Container 40': 846 Container 40' HC: 940 |

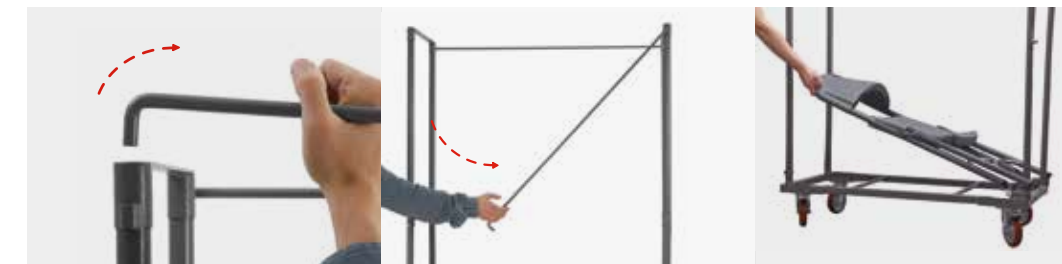


Ergonomic handle.
Asidero ergonómico.
Anse ergonomique.
Ergonomischer Griff.

Ergonomic crosspiece and seat.
Travesaño y asidero ergonómicos.
Barre transversale et siège ergonomiques.
Ergonomisch Sitz und geformte Querstrebe.

Ergonomic back.
Respaldo ergonómico.
Dossier ergonomique.
Ergonomische Rückenlehne.

Chair connector available. The distance between the two chairs with the link is 109 mm.
Conector de sillas disponible. La distancia entre las dos sillas con el link es de 109 mm.
Connecteur de chaises disponible. La distance entre les deux chaises avec le lien est de 109 mm.
Verbindungsstück für die Stühle erhältlich. Der Abstand zwischen den beiden Stühlen mit Verbindung beträgt 109 mm.



Easy locking and unlocking of the vertical posts. Ease of access for loading and unloading.
Fácil bloqueo y desbloqueo de los postes verticales. Cómodo acceso para cargar o descargar.
Poteaux verticaux faciles à bloquer et débloquer. Accès pratique pour chargement ou déchargement.
Leichtes Blockieren und Entriegeln der senkrechten Stangen. Bequemer Zugriff zum Ein- oder Ausladen.

stretch

classic

sashes



Vertical posts to hold the stacked chairs in place.
Postes verticales para inmovilizar las sillas apiladas.
Poteaux verticaux pour immobilisation des chaises empilées.
Senkrechte Stangen geben den gestapelten Stühlen Halt.

Four polyurethane wheels with built-in brake. (Two fixed wheels and two pivoting wheels).
4 ruedas de poliuretano con freno incorporado (2 ruedas fijas y 2 ruedas pivotantes).
4 roues en polyuréthane avec frein intégré. (2 roues fixes et 2 roues pivotantes).
4 PU-Räder mit integrierter Bremse. (2 feststehende Räder und 2 Schwenkräder).

Capacity: 27 pcs. Norman**chair**.
Capacidad: 27u. Normanchair**.**
Capacité: 27u. Norman**chair**.
Fassungsvermögen: 27 Stk. Normanchair**.**

aranchairplus

SHARK GREY

NEW

100%
PP



581-1
581-2 Contract
16139 L1



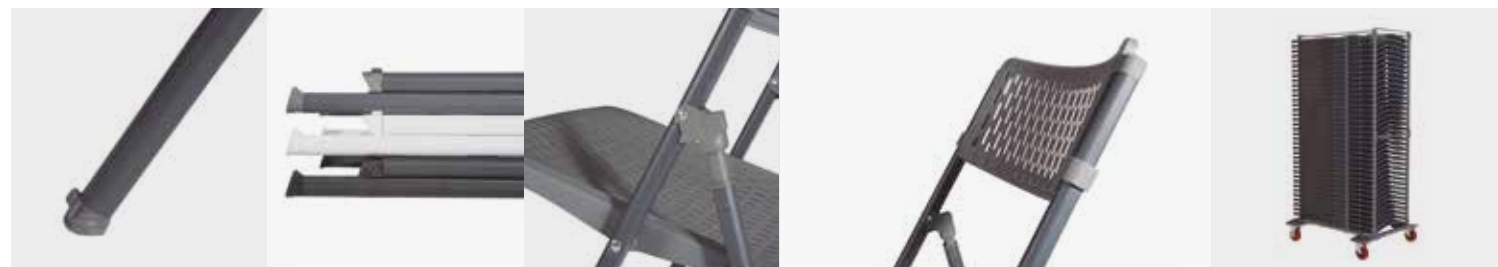
204 kg
450 lb
24 hours
(*) p. 31

4.32 kg
9.52 lb

5 Limited 5 year warranty



| Code Código Code | EAN | Name Nombre Nom Name | Units per box Unidades por caja Unités par boîte Stückzahl pro Packung | Packaging size Medidas embalaje Dimensions emballage Verpackungsmaße | Packaging volume Volumen embalaje Volume d'emballage Verpackungsvolumen | Gross weight Peso bruto Poids brut Bruttogewicht | Loading quantity Unidades por contenedor Unités par conteneur Einheiten pro Container |
|------------------------|---------------|-------------------------------|---|---|--|---|--|
| IC009X002A-SG | 8436539307082 | aranchair-sharkgrey | 4 | 52.7 x 21.17 x 105.9 cm | 0.13 m ³ | 18.36 kg | Container 40': 1968 |
| IC009X002A-BB | 8436539307068 | aranchair-black | | 20.75" x 8.37" x 41.37" | 4.59 ft ³ | 40.47 lb | Container 40' HC: 2232 |
| IC009X002A-WW | 8436539307105 | aranchair-white | | | | | |



Front leg caps especially designed to guarantee safe and stable stackability.

Taco de las patas frontales diseñado especialmente para garantizar una apilabilidad segura y estable.

Taquet des pieds frontaux spécialement conçu pour garantir un empilage sûr et stable.

Klotz der Vorderbeine mit speziellem Design zur Gewährleistung einer sicheren und stabilen Stapelbarkeit.

Piston-assisted folding mechanism.

Sistema de plegado con pistón.

Système de pliage avec piston.

Klappvorrichtung mit Kolben.

The perforated top gives breathability to the seat and back. It also facilitates drainage in case of rain.

La superficie perforada confiere transpirabilidad al asiento y respaldo. También facilita el drenaje en caso lluvia.

La surface perforée rend transpirable le siège et le dossier. Elle facilite également le drainage en cas de pluie.

Die gelochte Oberfläche von Sitz und Rückenlehne gewährleistet eine optimale Ventilation. Darüber hinaus erleichtert sie den Wasserablauf bei Niederschlag.

Arantrolley available for:
H1683mm: 31 pcs.
H1960mm: 37 pcs. See page 130.

Arantrolley disponible para: H1683mm: 31u. H1960mm: 37u. Ver pág. 130.

Arantrolley disponible pour 50 chaises. H1683mm: 31u. H1960mm: 37u. Voir page 130.

Wagen Arantrolley lieferbar für H1683mm: 31 Stk. H1960mm: 37 Stk. Siehe S. 130.

stretch

01503 01504 01505 01506 01507 01508 01509

classic

01510 01511 01512 01513 01514 01515 01516

sashes

classic twist plain

classic 0653 1171 1169 1168 0640 1170 0639
twist 0682 1175 1173 1172 0679 1174 0678
plain 0661 1179 1177 1176 0658 1178 0657

aranchairstandard

NEW

100%
PP



581-1
581-2 Contract
16139 L1



204 kg
450 lb
24 hours
(*) p. 31

4.32 kg
9.52 lb

5 Limited 5 year warranty



| Code Código Code | EAN | Name Nombre Nom Name | Units per box Unidades por caja Unités par boîte Stückzahl pro Packung | Packaging size Medidas embalaje Dimensions emballage Verpackungsmaße | Packaging volume Volumen embalaje Volume d'emballage Verpackungsvolumen | Gross weight Peso bruto Poids brut Bruttogewicht | Loading quantity Unidades por contenedor Unités par conteneur Einheiten pro Container |
|------------------------|---------------|-------------------------------|---|---|--|---|--|
| IC009X001A-SG | 8436539307075 | aranchair-sharkgrey | 4 | 52.7 x 21.17 x 105.9 cm | 0.13 m ³ | 18.36 kg | Container 40': 1968 |
| IC009X001A-BB | 8436539307051 | aranchair-black | | 20.75" x 8.37" x 41.37" | 4.64 ft ³ | 40.47 lb | Container 40' HC: 2232 |
| IC009X001A-WW | 8436539307099 | aranchair-white | | | | | |



Front leg caps especially designed to guarantee safe and stable stackability.

Taco de las patas frontales diseñado especialmente para garantizar una apilabilidad segura y estable.

Taquet des pieds frontaux spécialement conçu pour garantir un empilage sûr et stable.

Klotz der Vorderbeine mit speziellem Design zur Gewährleistung einer sicheren und stabilen Stapelbarkeit.

Piston-assisted folding mechanism.

Sistema de plegado con pistón.

Système de pliage avec piston.

Klappvorrichtung mit Kolben.

The perforated top gives breathability to the seat and back. It also facilitates drainage in case of rain.

La superficie perforada confiere transpirabilidad al asiento y respaldo. También facilita el drenaje en caso lluvia.

La surface perforée rend transpirable le siège et le dossier. Elle facilite également le drainage en cas de pluie.

Die gelochte Oberfläche von Sitz und Rückenlehne gewährleistet eine optimale Ventilation. Darüber hinaus erleichtert sie den Wasserablauf bei Niederschlag.

Arantrolley available for:
H1683mm: 31 pcs.
H1960mm: 37 pcs. See page 130.

Arantrolley disponible para: H1683mm: 31u. H1960mm: 37u. Ver pág. 130.

Arantrolley disponible pour 50 chaises. H1683mm: 31u. H1960mm: 37u. Voir page 130.

Wagen Arantrolley lieferbar für H1683mm: 31 Stk. H1960mm: 37 Stk. Siehe S. 130.

stretch

01503 01504 01505 01506 01507 01508 01509

classic

01510 01511 01512 01513 01514 01515 01516

sashes

classic twist plain

classic 0653 1171 1169 1168 0640 1170 0639
twist 0682 1175 1173 1172 0679 1174 0678
plain 0661 1179 1177 1176 0658 1178 0657

arantrolley

NEW

100%
POWDER
COATED
STEEL

16121 L2

L107.10 x W54.40 cm
L42.16" x W21.41"NW
21.61 kg
47.64 lb

| Code Código Code Code | EAN | Name Nombre Nom Name | Units per box Unidades por caja Unités par boîte Stückzahl pro Packung | Packaging size Medidas embalaje Dimensions emballage Verpackungsmaße | Packaging volume Volumen embalaje Volume d'emballage Verpackungsvolumen | Gross weight Peso bruto Poids brut Bruttogewicht | Loading quantity Unidades por contenedor Unités par conteneur Einheiten pro Container |
|--------------------------------|---------------|---|---|---|--|---|--|
| CB031F001 | 8436539307167 | aran trolley | 1 | L105 x W58.4 x H12.7 cm L41.375" x W23" x H5" | 0.07 m ³ 2.47 ft ³ | 23.90 kg 52.69 lb | Container 40': 770 Container 40' HC: 880 |

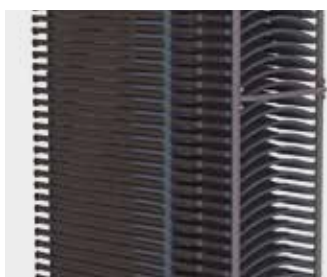


Easy locking and unlocking of the vertical posts. Ease of access for loading and unloading.

Fácil bloqueo y desbloqueo de los postes verticales. Cómodo acceso para cargar o descargar.

Poteaux verticaux faciles à bloquer et débloquer. Accès pratique pour chargement ou déchargement.

Leichtes Blockieren und Entriegeln der senkrechten Stangen. Bequemer Zugriff zum Ein- oder Ausladen.



Vertical posts to hold the stacked chairs in place.

Postes verticales para inmovilizar las sillas apiladas.

Poteaux verticaux pour immobilisation des chaises empilées.

Senkrechte Stangen geben den gestapelten Stühlen Halt.



Four polyurethane wheels with built-in brake. (Two fixed wheels and two pivoting wheels).

4 ruedas de poliuretano con freno incorporado (2 ruedas fijas y 2 ruedas pivotantes).

4 roues en polyuréthane avec frein intégré. (2 roues fixes et 2 roues pivotantes).

4 PU-Räder mit integrierter Bremse. (2 feststehende Räder und 2 Schwenkräder).



Capacity (H1683mm): 31 pcs. aranchair.
Capacity (H1960mm): 37 pcs. aranchair.

**Capacidad (H1683mm) : 31u. aranchair.
Capacidad (H1960mm): 37 u. aranchair.**

Capacité (H1683mm) : 31u. aranchair.
Capacité (H1960mm) : 31u. aranchair.

**Fassungsvermögen (H1683mm) : 31 Stk. aranchair.
Fassungsvermögen (H1960mm) : 37 Stk. aranchair.**

ludwigchair

NEW

100%
PURE HDPE.
NOT MIXED581-1
581-2 Contract
16139 L1226 kg
500 lb
24 hours
(* p. 31)3.80 kg
8.37 lbPP Shark Grey
POWDER-COATED
STEEL
Shark GreyPP Black
POWDER-COATED
STEEL
BlackPP White
POWDER-COATED
STEEL
White

| Code Código Code Code | EAN | Name Nombre Nom Name | Units per box Unidades por caja Unités par boîte Stückzahl pro Packung | Packaging size Medidas embalaje Dimensions emballage Verpackungsmaße | Packaging volume Volumen embalaje Volume d'emballage Verpackungsvolumen | Gross weight Peso bruto Poids brut Bruttogewicht | Loading quantity Unidades por contenedor Unités par conteneur Einheiten pro Container |
|--------------------------------|---------------|--|---|---|--|---|--|
| PC020X001A-SG | 8436539309727 | ludwig chair -sharkgrey | 4 | 47.92 x 21.9 x 108.58 cm | 0.11 m ³ 4.02 ft ³ | 17.04 kg 37.56 lb | Container 40': 2048 Container 40' HC: 2360 |
| PC020X001A-BB | 8436539309741 | ludwig chair -black | | 18.87 x 8.625 x 42.75" | | | |
| PC020X001A-WW | 8436539309734 | ludwig chair -white | | | | | |



Front leg caps especially designed to guarantee safe and stable stackability.

Taco de las patas frontales diseñado especialmente para garantizar una apilabilidad segura y estable.

Taquet des pieds frontaux spécialement conçu pour garantir un empilage sûr et stable.

Klotz der Vorderbeine mit speziellem Design zur Gewährleistung einer sicheren und stabilen Stapelbarkeit.



Hole in the seat to facilitate drainage in the event of rain.

Orificio en el asiento para facilitar el drenaje en caso de lluvia.

Orifice dans la chaise pour faciliter le drainage en cas de pluie.

Öffnung in der Sitzfläche für optimalen Wasserablauf bei Niederschlag.



Liam Trolley available for 36 chairs. See page 135.

Liam Trolley disponible para 36 sillas. Ver página: 135.

Liam Trolley disponible pour 36 chaises. Voir page 135.

Liam-Trolley für 36 Stühle. Siehe Seite: 135.



boston-kchair

100%
POWDER
COATED
STEEL



581-1
581-2 Contract
16139 L1

NEW



225 kg
500 lb



4.30 kg
9.46 lb



Limited 5 year
warranty

| Code Código Code Code | EAN | Name Nombre Nom Name | Units per box Unidades por caja Unités par boîte Stückzahl pro Packung | Packaging size Medidas embalaje Dimensions emballage Verpackungsmaße | Packaging volume Volumen embalaje Volume d'emballage Verpackungsvolumen | Gross weight Peso bruto Poids brut Bruttogewicht | Loading quantity Unidades por contenedor Unités par conteneur Einheiten pro Container |
|--------------------------------|---------------|-------------------------------|---|---|--|---|--|
| SC-35K-SG | 8436539309758 | boston-kchair | 4 | 97.5 x 21.3 x 51.1 cm 38.4" x 8.4" x 20.1" | 0.11 m³ 3.75 ft³ | 18.9 kg 41.66 lb | Container 40': 2304 Container 40' HC: 2640 |



With joining system.

Con sistema de unión.

Avec système de raccord.

Mit Verbindungssys.

stretch



-
-
-
-
-
-
-

classic



-
-
-
-
-
-
-

sashes



- | | | | | | | | |
|---------|--|--|--|--|--|--|--|
| classic | | | | | | | |
| twist | | | | | | | |
| plain | | | | | | | |

liamtrolley

100%
POWDER
COATED
STEEL



16121 L2



L175 x W79 cm
L68.9" x W31.1"



24.69 kg
54.40 lb

| Code Código Code Code | EAN | Name Nombre Nom Name | Units per box Unidades por caja Unités par boîte Stückzahl pro Packung | Packaging size Medidas embalaje Dimensions emballage Verpackungsmaße | Packaging volume Volumen embalaje Volume d'emballage Verpackungsvolumen | Gross weight Peso bruto Poids brut Bruttogewicht | Loading quantity Unidades por contenedor Unités par conteneur Einheiten pro Container |
|--------------------------------|---------------|-------------------------------|---|---|--|---|--|
| CB002F005 | 8436539296713 | liamtrolley | 1 | 176.5 x 88.3 x 15.2 cm 69.5" x 34.7" x 6" | 0.23 m³ 8.12 ft³ | 28.98 kg 63.88 lb | Container 40': 252 Container 40' HC: 280 |



Capacity for a wide range of chairs. 48 alexandra / 48 alex / 24 norma / 24 otto / 18 alvarstool / 30 boston / 48 bigalexchair / 36 aranchair / 36 ludwigchair / 36 olafchair / 36 olafskidchair.

Capacidad para una amplia variedad de sillas. 48 alexandra / 48 alex / 24 norma / 24 otto / 18 alvarstool / 30 boston / 48 bigalexchair / 36 aranchair / 36 ludwigchair / 36 olafchair / 36 olafskidchair.

Capacité pour une large variété de chaises. 48 alexandra / 48 alex / 24 norma / 24 otto / 18 alvarstool / 30 boston / 48 bigalexchair / 36 aranchair / 36 ludwigchair / 36 olafchair / 36 olafskidchair.

Aufnahmevermögen für verschiedenste Stühle. 48 alexandra / 48 alex / 24 norma / 24 otto / 18 alvarstool / 30 boston / 48 bigalexchair / 36 aranchair / 36 ludwigchair / 36 olafchair / 36 olafskidchair.



Integrated brakes in 2 of its 4 wheels.
Frenos incorporados en 2 de sus 4 ruedas.
2 des 4 roues sont munies d'un frein.
Mit Bremsen an 2 der 4 Rädern.



Scratch protector to prevent scratches on walls.
Anti-scratch. Protector para evitar rayar las paredes.
Anti-rayures. Protection évitant les rayures sur les murs.
Kratzschutz. Schutzvorrichtung gegen Kratzer an den Wänden.

malmöchair

UPHOLSTERED
PLYWOOD SEATUPHOLSTERED
METAL PLATE
BACKREST16139 L1
BS-5852

NEW



| Code Código Code Code | EAN | Name Nombre Nom Name | Units per box Unidades por caja Unités par boîte Stückzahl pro Packung | Packaging size Medidas embalaje Dimensions emballage Verpackungsmaße | Packaging volume Volumen embalaje Volume d'emballage Verpackungsvolumen | Gross weight Peso bruto Poids brut Bruttogewicht | Loading quantity Unidades por contenedor Unités par conteneur Einheiten pro Container |
|--------------------------------|---------------|-------------------------------|---|---|--|---|--|
| FC010A004A | 8436539309772 | malmöchair | 4 | 49.53 x 37.14 x 103.18 cm 19.5" x 14.62" x 40.62" | 0.19 m ³ 6.70 ft ³ | 22.30 kg 49.16 lb | Container 40': 1192 Container 40' HC: 1376 |



Padded seat and backrest upholstered in grey/black fabric with fire retardant treatment (BS-5852).

Asiento y respaldo acolchados y tapizados en trama gris/negro con tratamiento ignífugo (BS-5852).

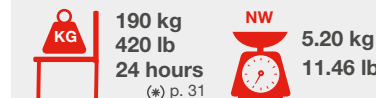
Chaise et dossier capitonnés et recouverts de tissu gris/noir avec traitement ignifuge (BS-5852).

Sitzfläche und Rückenlehne gepolstert und grau/schwarz tapeziert mit brandhemmender Behandlung (BS-5852).

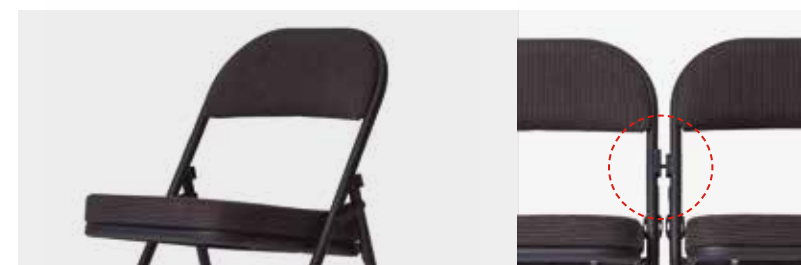
malmö-kchair

UPHOLSTERED
PLYWOOD SEATUPHOLSTERED
METAL PLATE
BACKREST16139 L1
BS-5852

NEW



| Code Código Code Code | EAN | Name Nombre Nom Name | Units per box Unidades por caja Unités par boîte Stückzahl pro Packung | Packaging size Medidas embalaje Dimensions emballage Verpackungsmaße | Packaging volume Volumen embalaje Volume d'emballage Verpackungsvolumen | Gross weight Peso bruto Poids brut Bruttogewicht | Loading quantity Unidades por contenedor Unités par conteneur Einheiten pro Container |
|--------------------------------|---------------|-------------------------------|---|---|--|---|--|
| FC010A003A | 8436539308492 | malmö-kchair | 4 | 50.48 x 36.51 x 102.30 cm 19.87" x 14.37" x 40.25" | 0.20 m ³ 6.98 ft ³ | 22.86 kg 50.39 lb | Container 40': 1192 Container 40' HC: 1376 |



Padded seat and backrest upholstered in grey/black fabric with fire retardant treatment (BS-5852).

Asiento y respaldo acolchados y tapizados en trama gris/negro con tratamiento ignífugo (BS-5852).

Chaise et dossier capitonnés et recouverts de tissu gris/noir avec traitement ignifuge (BS-5852).

Sitzfläche und Rückenlehne gepolstert und grau/schwarz tapeziert mit brandhemmender Behandlung (BS-5852).

With joining system.

Con sistema de unión.

Avec système de raccord.

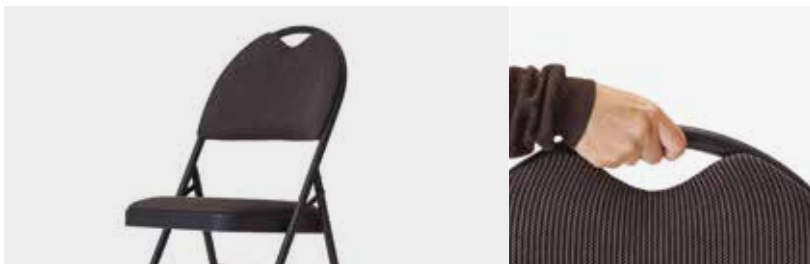
Mit Verbindungssystem.

günther**chair**

NEW

UPHOLSTERED
MDF SEATUPHOLSTERED
METAL PLATE
BACKREST16139 L1
BS-5852

| Code Código Code Code | EAN | Name Nombre Nom Name | Units per box Unidades por caja Unités par boîte Stückzahl pro Packung | Packaging size Medidas embalaje Dimensions emballage Verpackungsmaße | Packaging volume Volumen embalaje Volume d'emballage Verpackungsvolumen | Gross weight Peso bruto Poids brut Bruttogewicht | Loading quantity Unidades por contenedor Unités par conteneur Einheiten pro Container |
|--------------------------------|---------------|-------------------------------|---|---|--|---|--|
| FC001A002A | 8436539296607 | günther chair | 4 | 48.56 x 24.13 x 114.93 cm 19.12" x 9.5" x 45.25" | 0.13 m3 4.76 ft3 | 22.7 kg 50 lb | Container 40': 1720 Container 40' HC: 1952 |



Padded seat and backrest upholstered in grey/black fabric with fire retardant treatment (BS-5852).

Asiento y respaldo acolchados y tapizados en trama gris/negro con tratamiento ignífugo (BS-5852).

Chaise et dossier capitonnés et recouverts de tissu gris/noir avec traitement ignifuge (BS-5852).

Sitzfläche und Rückenlehne gepolstert und grau/schwarz tapeziert mit brandhemmender Behandlung (BS-5852).

Handle for easy manoeuvring of the chair.

Asa para facilitar el manejo y desplazamiento de la silla.

Anse pour faciliter le maniement et le déplacement de la chaise.

Griff zum leichteren Handhaben und Bewegen des Stuhls.

günther-**k**chair

NEW

UPHOLSTERED
MDF SEATUPHOLSTERED
METAL PLATE
BACKREST16139 L1
BS-5852

| Code Código Code Code | EAN | Name Nombre Nom Name | Units per box Unidades por caja Unités par boîte Stückzahl pro Packung | Packaging size Medidas embalaje Dimensions emballage Verpackungsmaße | Packaging volume Volumen embalaje Volume d'emballage Verpackungsvolumen | Gross weight Peso bruto Poids brut Bruttogewicht | Loading quantity Unidades por contenedor Unités par conteneur Einheiten pro Container |
|--------------------------------|---------------|-------------------------------|---|---|--|---|--|
| FC001A006A | 8436539309789 | günther- k chair | 4 | 51.75 x 24.13 x 114.93 cm 20.37" x 9.5" x 45.25" | 0.14 m3 5.07 ft3 | 22.7 kg 50 lb | Container 40': 1672 Container 40' HC: 1880 |



Padded seat and backrest upholstered in grey/black fabric with fire retardant treatment (BS-5852).

Asiento y respaldo acolchados y tapizados en trama gris/negro con tratamiento ignífugo (BS-5852).

Chaise et dossier capitonnés et recouverts de tissu gris/noir avec traitement ignifuge (BS-5852).

Sitzfläche und Rückenlehne gepolstert und grau/schwarz tapeziert mit brandhemmender Behandlung (BS-5852).

Handle for easy manoeuvring of the chair.

Asa para facilitar el manejo y desplazamiento de la silla.

Anse pour faciliter le maniement et le déplacement de la chaise.

Griff zum leichteren Handhaben und Bewegen des Stuhls.

With joining system.

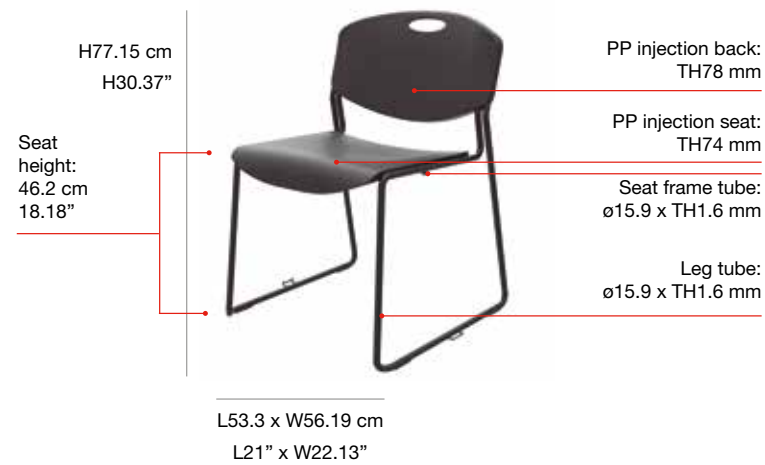
Con sistema de unión.

Avec système de raccord.

Mit Verbindungssystem.

bryggen-k**chair**

NEW

100%
PP581-1
581-2 Contract
16139 L1

| Code Código Code | EAN | Name Nombre Nom Name | Units per box Unidades por caja Unités par boîte Stückzahl pro Packung | Packaging size Medidas embalaje Dimensions emballage Verpackungsmaße | Packaging volume Volumen embalaje Volume d'emballage Verpackungsvolumen | Gross weight Peso bruto Poids brut Bruttogewicht | Loading quantity Unidades por contenedor Unités par conteneur Einheiten pro Container |
|------------------------|---------------|-------------------------------|---|---|--|---|--|
| SK0071002A-BB | 8436539309710 | bryggen-k chair | 40 pcs/stack | 89.53 x 57.78 x 254 cm 35.25" x 22.75 x 100" | 1.31 m ³ 46.40 ft ³ | 226.5 kg 499 lb | Container 40' HC: 2080 pcs/ 52 stacks Container 40': 1768 pcs/ 52 stacks |



Wide seat and backrest (53 cm) for great comfort.

Asiento y respaldo de gran amplitud y confort (53 cm).

Chaise et dossier d'une grande amplitude et de grand confort (53 cm).

Besonders breite und bequeme Sitzfläche und Rückenlehne (53 cm).

Stackable up to 8 chairs.

Apilable hasta 8 sillas.

Empilables jusqu'à 8 chaises.

Bis zu 8 Stühlen stapelbar.

Handle for easy manoeuvring of the chair.

Asa para facilitar el manejo y desplazamiento de la silla.

Anse pour faciliter le maniement et le déplacement de la chaise.

Griff zum leichteren Handhaben und Bewegen des Stuhls.

Sled base frame with in-built joining system.

Estructura de pie patin con sistema de unión incorporado.

Structure de pied patin avec système d'union incorporé.

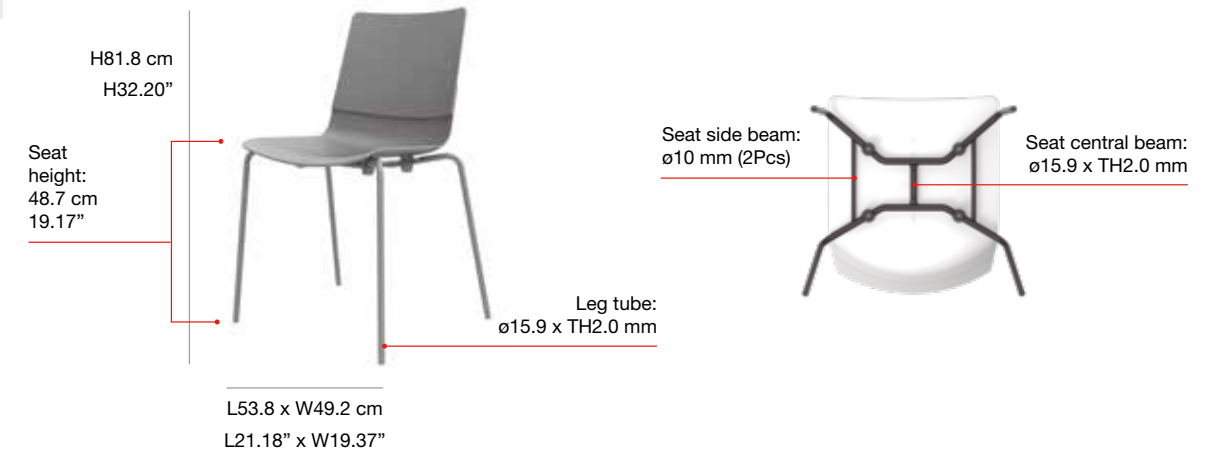
Kufenförmiges Beingestell mit integriertem Verbindungssystem.

truman**chair**

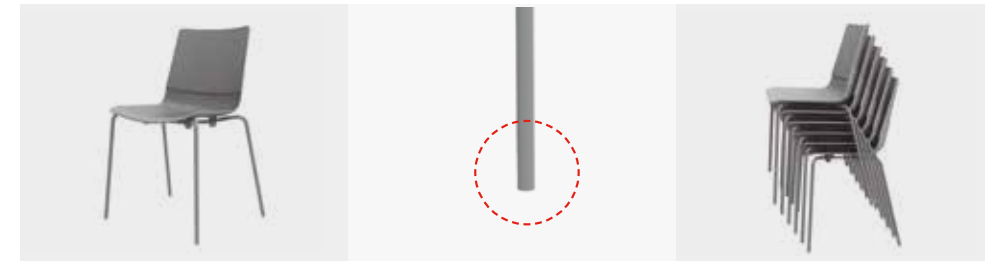
NEW

100%
PP

16139 L1



| Code Código Code | EAN | Name Nombre Nom Name | Units per box Unidades por caja Unités par boîte Stückzahl pro Packung | Packaging size Medidas embalaje Dimensions emballage Verpackungsmaße | Packaging volume Volumen embalaje Volume d'emballage Verpackungsvolumen | Gross weight Peso bruto Poids brut Bruttogewicht | Loading quantity Unidades por contenedor Unités par conteneur Einheiten pro Container |
|------------------------|---------------|--------------------------------|---|---|--|---|--|
| SK0171001A-SG | 8436539309765 | truman chair -sharkgrey | 6 pcs/stack | 66.34 x 56.18 x 113 cm 26.12" x 22.12 x 44.5" | 0.42 m ³ 14.87 ft ³ | 33.74 kg 74.38 lb | Container 40': 852 |
| SK0171001A-BB | 8436539304524 | truman chair -black | | | | | |
| SK0171001A-WW | 8436539304531 | truman chair -white | | | | | |



Polypropylene injected single-piece seat and backrest.

Asiento y respaldo de una sola pieza inyectada en polipropileno.

Chaise et dossier d'une seule pièce injectée en polypropylène.

Sitzfläche und Rückenlehne aus einem einzigen Polypropylen-Spritzgussteil.

Built-in leg caps.

Tacos de las patas integrados.

Embouts des pattes intégrés.

In den Beinen integrierte Schutzkappen.

Stackable up to 6 chairs.

Apilable hasta 6 sillas.

Empilables jusqu'à 6 chaises.

Bis zu 6 Stühlen stapelbar.

almachair

100%
POWDER
COATED STEEL
CATAPHORESIS581-1
581-2 Contract

| Code Código Code Code | EAN | Name Nombre Nom Name | Units per box Unidades por caja Unités par boîte Stückzahl pro Packung | Packaging size Medidas embalaje Dimensions emballage Verpackungsmaße | Packaging volume Volumen embalaje Volume d'emballage Verpackungsvolumen | Gross weight Peso bruto Poids brut Bruttogewicht | Loading quantity Unidades por contenedor Unités par conteneur Einheiten pro Container |
|--------------------------------|--------------------------------|-------------------------------|---|---|--|---|--|
| SK014F001A-DB SK014F001A-W | 8436539299684 8436539299677 | almachair | 34 pcs / stack | 96.5 x 55.25 x 223.5 cm 38" x 21.75" x 88" | 1.19 m ³ 42 ft ³ | 192 kg / stack 423 lb / stack | Container 40': 1632 pcs / 48 stacks Container 40' HC: - |
| SK014F001A-DB SK014F001A-W | 8436539299684 8436539299677 | almachair | 4 pcs / box | 72 x 132 x 54 cm 28.34" x 51.96" x 21.25" | 0.51 m ³ 18 ft ³ | 26.32 kg 58 lb | - |
| SK014F001A-DB SK014F001A-W | 8436539299684 8436539299677 | almachair | 26 pcs / pallet | 120 x 80 x 187 cm 47.27" x 31.5" x 73.62" | 1.79 m ³ 63.2 ft ³ | 159.10 kg 350 lb | - |

almaarmchair

100%
POWDER
COATED STEEL
CATAPHORESIS581-1
581-2 Contract

| Code Código Code Code | EAN | Name Nombre Nom Name | Units per box Unidades por caja Unités par boîte Stückzahl pro Packung | Packaging size Medidas embalaje Dimensions emballage Verpackungsmaße | Packaging volume Volumen embalaje Volume d'emballage Verpackungsvolumen | Gross weight Peso bruto Poids brut Bruttogewicht | Loading quantity Unidades por contenedor Unités par conteneur Einheiten pro Container |
|--------------------------------|--------------------------------|-------------------------------|---|---|--|---|--|
| SK014F002A-DB SK014F002A-W | 8436539299707 8436539299691 | almaarmchair | 33 pcs / stack | 96.5 x 60.96 x 223.5 cm 38" x 24" x 88" | 1.31 m ³ 46.26 ft ³ | 215.15 kg 474.32 lb / stack | Container 40': 1419 pcs / 43 stacks Container 40' HC: - |
| SK014F002A-DB SK014F002A-W | 8436539299707 8436539299691 | almaarmchair | 4 pcs / box | 72 x 132 x 54 cm 28.34" x 51.96" x 21.25" | 0.51 m ³ 18 ft ³ | 29.8 kg 66.76 lb / stack | - |
| SK014F002A-DB SK014F002A-W | 8436539299707 8436539299691 | almaarmchair | 26 pcs / pallet | 120 x 80 x 187 cm 47.27" x 31.5" x 73.62" | 1.79 m ³ 63.2 ft ³ | 170.80 kg 376.54 lb | - |

Dark bronze
POWDER-COATED
STEEL
Dark bronzeWhite
POWDER-COATED
STEEL
WhiteStackable up to 6 chairs.
Apilable hasta 6 sillas.
Empilable jusqu'à 6 chaises.
Stapelbar bis zu 6 Stühlen.Dark bronze
POWDER-COATED
STEEL
Dark bronzeWhite
POWDER-COATED
STEEL
WhiteStackable up to 6 chairs.
Apilable hasta 6 sillas.
Empilable jusqu'à 6 chaises.
Stapelbar bis zu 6 Stühlen.



displayrack

100%
POWDER
COATED STEEL



L64.1 x W61 cm
L25.2" x W24"

NW
11.20 kg
24.70 lb

| Code Código Code Code | EAN | Name Nombre Nom Name | Units per box Unidades por caja Unités par boîte Stückzahl pro Packung | Packaging size Medidas embalaje Dimensions emballage Verpackungsmaße | Packaging volume Volumen embalaje Volume d'emballage Verpackungsvolumen | Gross weight Peso bruto Poids brut Bruttogewicht | Loading quantity Unidades por contenedor Unités par conteneur Einheiten pro Container |
|--------------------------------|---------------|-------------------------------|---|---|--|---|--|
| RA-287 | 8437010781308 | displayrack | 1 | 72.7 x 26 x 66.7 cm 28.6" x 10.2" x 26.2" | 0.12 m ³ 4.44 ft ³ | 13.20 kg 29.04 lb | Container 40': 480 Container 40' HC: 574 |



Easy to assemble and disassemble.

Fácil de montar y desmontar.

Facile à monter et à démonter.

Einfach auf- und abzubauen.

Maxchief Europe S.L. reserves the right to modify or remove from the catalogue at any time and without prior notice any of the products described in it. For this reason, we cannot guarantee the availability of the products or that the specifications, colours, forms and other characteristics reproduced coincide at all times and in all details with the real ones. The total or partial reproduction of the content of this publication is strictly prohibited, as well as the images and texts that are the intellectual property of Maxchief Europe S.L., without previous written authorisation.

Maxchief Europe S.L. se reserva el derecho de modificar o descatalogar en cualquier momento y sin previo aviso cualquiera de los modelos descritos en este catálogo. Por ello, no garantiza la disponibilidad de los modelos ni que las especificaciones, colores, formas y demás características que se reproducen coincidan en todo momento y con todo detalle con los reales. Queda prohibida la reproducción total o parcial del contenido de esta publicación, así como de imágenes y textos propiedad intelectual de Maxchief Europe S.L., salvo previa autorización.

Maxchief Europe S.L. se réserve le droit de modifier ou de sortir du catalogue à tout moment et sans préavis n'importe lequel des produits décrits dans ce catalogue. C'est pourquoi elle ne garantit pas la disponibilité des produits. Elle ne garantit pas non plus que les spécifications, les couleurs, les formes et les autres caractéristiques reproduites coïncident à tout moment et dans le moindre détail avec les réelles. Il est interdit de reproduire totalement ou partiellement le contenu de cette publication, ainsi que les images et les textes, propriété intellectuelle de Maxchief Europe S.L., sauf autorisation préalable par écrit.

Maxchief Europe S.L. behält sich das Recht vor, jedes Produkt in diesem Katalog jederzeit und ohne vorherige Ankündigung zu ändern oder aus dem Lieferprogramm zu nehmen. Das Unternehmen gewährleistet daher nicht, dass die einzelnen Produkte verfügbar sind bzw. dass die tatsächlichen Spezifikationen, Farben, Formen und sonstigen Merkmale jederzeit genau mit den angegebenen übereinstimmen. Die vollständige oder teilweise Wiedergabe des Inhalts dieser Publikation sowie der Bilder und Texte, die geistiges Eigentum von Maxchief Europe S.L. sind, ist ohne vorherige schriftliche Genehmigung verboten.





Collection summary
Resumen colección
Résumé collection
Übersicht kollektion

M183

new zawn classic

TABLE MESA TABLE TISCH

PT-033-NC
183 x 46 x H74 cm
72" x 18.1" x H29.1"

Pg. 33



L120

new zawn classic

TABLE MESA TABLE TISCH

BT004X015
121.9 x 61 x H74.3 cm
4' x 24" x H29.3"

Pg. 34



Ltrolley

TROLLEY CARRO CHARIOT WAGEN

RA-101A
131.7 x 62 x H115 cm
51.9" x 24.4" x H45.3"

Pg. 35



XL120

new zawn classic

TABLE MESA TABLE TISCH

BT004X014
121.9 x 76 x H74.3 cm
4' x 30" x H29.25"

Pg. 36



XL150

new zawn classic

TABLE MESA TABLE TISCH

BT005X012
152.4 x 76.2 x H74.3 cm
5' x 30" x H29.3"

Pg. 40



XL180

new zawn classic

TABLE MESA TABLE TISCH

BT006X020
182.9 x 75.2 x H74.3 cm
6' x 29.6" x H29.3"

Pg. 42



XL180vintage

TABLE MESA TABLE TISCH

BT-06BK
182.9 x 76.2 x H74.3 cm
6' x 29.6" x H29.3"

Pg. 44



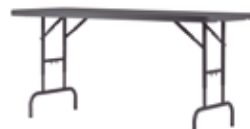
worktop180

new zawn classic

TABLE MESA TABLE TISCH

BT-06A-002-NC
182.9 x 75.2 x H74.3/85.1/90.2/94.3 cm
6' x 29.6" x H29.3"/33.5"/35.5"/37.1"

Pg. 46



topshelf180

new zawn classic

SHELF ESTANTE SHELF SHELF

PT-36-NC
184 x 30.5 x H31 cm
6' x 12" x H12.2"

Pg. 48



XL240

new zawn classic

TABLE MESA TABLE TISCH

BT008X010
243.8 x 76.2 x H74.3 cm
8' x 30" x H29.3"

Pg. 50



XLtrolley

TROLLEY CARRO CHARIOT WAGEN

RA-102A
(193+61) x 77 x H115 cm
(76"+24") x 30.3" x H45.3"

Pg. 52



XLmoon

new zawn classic

TABLE MESA TABLE TISCH

PT015X001
243.8 x 76.2 x H74.3 cm
8' x 30" x H29.2"

Pg. 54



XLcorner

new zawn classic

TABLE MESA TABLE TISCH

PT-32-NC
75.1 x 75.1 x H74.3 cm
29.5" x 29.5" x H29.2"

Pg. 58



XXL90

new zawn classic

TABLE MESA TABLE TISCH

BT-36-NC
91.4 x 91.4 x H74.3 cm
36" x 36" x H29.3"

Pg. 60



XXL180

new zawn classic

TABLE MESA TABLE TISCH

PT050X001
182.9 x 91.4 x H74.3 cm
6' x 36" x H29.3"

Pg. 62



XXL200

new zawn classic

TABLE MESA TABLE TISCH

PT024X002
198.2 x 91.4 x H74.3 cm
6.5' x 36" x H29.3"

Pg. 66



XXL240

new zawn classic

TABLE MESA TABLE TISCH

PT012X004
240 x 91.4 x H74.3 cm
8' x 36" x H29.3"

Pg. 70



XXLtrolley

TROLLEY CARRO CHARIOT WAGEN

RA-105A
(202+46) x 92 x H115 cm
(79.6"+18.1") x 36.2" x H45.3"

Pg. 72



XXLmoon

new zawn classic

TABLE MESA TABLE TISCH

PT016X002
181.5 x 76.2 x H74.3 cm
8' x 30" x H29.2"

Pg. 74



XXLcorner

new zawn classic

TABLE MESA TABLE TISCH

PT-33-NC
91.4 x 91.4 x H74.3 cm
3' x 3" x H29.2"

Pg. 76



planet120

new zawn classic

TABLE MESA TABLE TISCH

BT-48J-NC
Ø122 x H74.3 cm
Ø4' x H29.3"

Pg. 78



planet150

new zawn classic

TABLE MESA TABLE TISCH

BT-60J-NC
Ø152.4 x H74.3 cm
Ø5' x H29.2"

Pg. 80



planet160

new zawn classic

TABLE MESA TABLE TISCH

BT-63-NC
Ø160 x H74.3 cm
Ø5.25" x H29.2"

Pg. 84



planet180

new zawn classic

TABLE MESA TABLE TISCH

BT-71-NC
Ø180.3 x H74.3 cm
Ø5.92" x H29.2"

Pg. 86



planettrolley

TROLLEY CARRO CHARIOT WAGEN

RA-106A
(132+30) x 83.2 x H102 cm
(52"+11.8") x 32.7" x H40.2"

Pg. 90



multitrolley^{NEW}

TROLLEY CARRO CHARIOT WAGEN

CB034F001A
168.2 x 85 x H120.6 cm
68.22" x 33.46" x H47.48"

Pg. 92



cocktail80

new zawn classic

TABLE MESA TABLE TISCH

PT-36-NC
Ø81.3 x H110 cm
Ø32" x H43.3"

Pg. 94



praxis80

new zawn classic

TABLE MESA TABLE TISCH

PT-37-NC
Ø81.3 x H74.3 cm
Ø32" x H29.3"

Pg. 100



bistrot70

TABLE MESA TABLE TISCH

BT009X001A
68.6 x 68.6 x H74.3 cm
27" x 27" x H29.5"

Pg. 101



cocktailtrolley

TROLLEY CARRO CHARIOT WAGEN

RA-277
125.5 x 89 x H101 cm
49.4" x 35" x H39.6"

Pg. 104



oktober175

new zown classic

BENCH **BANCO** BANC BANK

PC-10-SG
175.3 x 29.2 x H46.4 cm
69" x 11.5" x H18.3"

Pg. 105



sharpbench180 sharp**table**

new zown classic

BENCH **BANCO** BANC BANK

PC-15F-SG
184 x 30.5 x H44.3 cm
6' x 12" x H17.5"

Pg. 106



TABLE **MESA** TABLE **TISCH**

BT-06FG-NC
182.9 x 76.2 x H75.2 cm
6' x 29.6" x H29.2"

Pg. 107



munich50

TABLE **MESA** TABLE **TISCH**

PT004X002A
220 x 50 x H77 cm
86.6" x 19.6" x H30.3"

Pg. 108



munich70

TABLE **MESA** TABLE **TISCH**

PT-46
220 x 67 x H77 cm
86.6" x 26.4" x H30.3"

Pg. 110



munich**bench**

BENCH **BANCO** BANC BANK

PC-27
220 x 30 x H48 cm
86.6" x 11.8" x H18.9"

Pg. 111



dakotapicnic**set** **SS60**

TABLE **MESA** TABLE **TISCH**

PT046X001
182.8 x 144.3 x H74.6 cm
71.96" x 56.81" x H29.37"

Pg. 112



TABLE **MESA** TABLE **TISCH**

OT002X001
61 x 61 x H89 cm
24" x 24" x H35"

Pg. 114



SS120

TABLE **MESA** TABLE **TISCH**

OT001X001
122 x 61 x H89 cm
48" x 24" x H35"

Pg. 115



display**rack**

DISPLAY RACK **EXPOSITOR** SUPPORT
D'EXPOSITION **AUSSTELLUNGSTÄNDER**

RA-287
64.1 x 61 x H71.1cm
25.2" x 24" x H28"

Pg. 146



alvar**stool**

new zown classic

STOOL **TABURETE** TABOURET **HOCKER**

PC-019-SG
51.8 x 56.6 x H104.6 cm
20.4" x 22.3" x H41.1"

Pg. 96



alex**chair**NC

CHAIR **SILLA** CHAISE **STUHL**

GC-52
44.2 x 45 x H80.3 cm
17.63" x 17.7" x H31.6"

Pg. 116



mega-**connector** **bigalexchair**

NEW for alexchair

CHAIR **SILLA** CHAISE **STUHL**

RA078X001A-H
22.2 x 4 x H5.3 cm
22.2 x 3.5 x H2.5 cm
8.74" x 1.37" x H0.89"

Pg. 117



CHAIR **SILLA** CHAISE **STUHL**

CO08X001A
50.9 x 50.3 x 80.6 cm
20" x 19.8" x 31.7"

Pg. 118



TROLLEY **CARRO** CHARIOT **WAGEN**

RA-CB030F001
104.2 x 52.2 x H168/H196.4 cm
41" x 20.5" x H66.1"/H77.3"

Pg. 119



alex**trolley**

TROLLEY **CARRO** CHARIOT **WAGEN**

RA-104A
95.4 x 47.5 x H196.8 cm
37.5" x 18.7" x H77.5"

Pg. 122



olaf**chair** **NEW**

CHAIR **SILLA** CHAISE **STUHL**

IC004X003A
46 x 50.5 x H78.74 cm
18.13" x 19.84" x H31"

Pg. 124



olafskid**chair** **NEW**

CHAIR **SILLA** CHAISE **STUHL**

IC004X004A
46 x 50.46 x H78.74 cm
18.12" x 19.87" x H31"

Pg. 125



norman**chair**

CHAIR **SILLA** CHAISE **STUHL**

PC-23-SG
47 x 50.7 x H85.8 cm
18.5" x 19.96" x H33.78"

Pg. 126



norman**trolley**

TROLLEY **CARRO** CHARIOT **WAGEN**

RA-103-01
110 x 48 x H190 cm
43.3" x 18.9" x H74.8"

Pg. 127



aran**chair**plus **NEW**

CHAIR **SILLA** CHAISE **STUHL**

IC009X002A
51 x 52.8 x H81.2 cm
20.07" x 20.78" x H31.96"

Pg. 128



aran**chair**standard **NEW**

CHAIR **SILLA** CHAISE **STUHL**

IC009X001A
51 x 52.8 x H81.2 cm
20" x 20.79" x H31.97"

Pg. 129



aran**trolley** **NEW**

TROLLEY **CARRO** CHARIOT **WAGEN**

RA-CB031F001
107.1 x 54.4 x H196 cm/H168.3 cm
42.1" x 21.4" x H77.1"/H66.2"

Pg. 130



ludwig**chair** **NEW**

CHAIR **SILLA** CHAISE **STUHL**

PC020X001A
47.2 x 53.5 x H83.7 cm
18.58" x 21.06" x H32.95"

Pg. 131



boston-**kchair** **NEW**

CHAIR **SILLA** CHAISE **STUHL**

SC-35K-SG
49.5 x 50.8 x H75 cm
19.5" x 20" x H29.6"

Pg. 134



liam**trolley**

TROLLEY **CARRO** CHARIOT **WAGEN**

CB002F005
175 x 79 x H123.5cm
68.9" x 31.1" x H48.6"

Pg. 135



malmö**chair** **NEW**

CHAIR **SILLA** CHAISE **STUHL**

FC010A004A
47 x 52 x H81.9 cm
17.7" x 17" x H32.25"

Pg. 136



malmö-**kchair** **NEW**

CHAIR **SILLA** CHAISE **STUHL**

FC010A003A
49.2 x 52 x H81.9 cm
19.37" x 20.5" x H32.25"

Pg. 137



günther**chair** **NEW**

CHAIR **SILLA** CHAISE **STUHL**

FC001A002A
47 x 49.5 x H90.8 cm
18.5" x 19.5" x H35.75"

Pg. 138



günther-**kchair** **NEW**

CHAIR **SILLA** CHAISE **STUHL**

FC001A006A
49.5 x 49.5 x H90.8 cm
19.5" x 19.5" x H35.75"

Pg. 139



bryggen-k^{NEW}chair truman^{NEW}chair almachair

CHAIR SILLA CHAISE STUHL

SK007I002A
53.3 x 56.19 x H77.15 cm
21" x 22.13" x H30.37"

Pg. 140



CHAIR SILLA CHAISE STUHL

SK017I001A
53.8 x 49.2 x H81.8 cm
21.18" x 19.37" x H32.20"

Pg. 141



CHAIR SILLA CHAISE STUHL

SK014F001A
47.4 x 51.7 x H82.6 cm
18.7" x 20.3" x H32.5"

Pg. 142

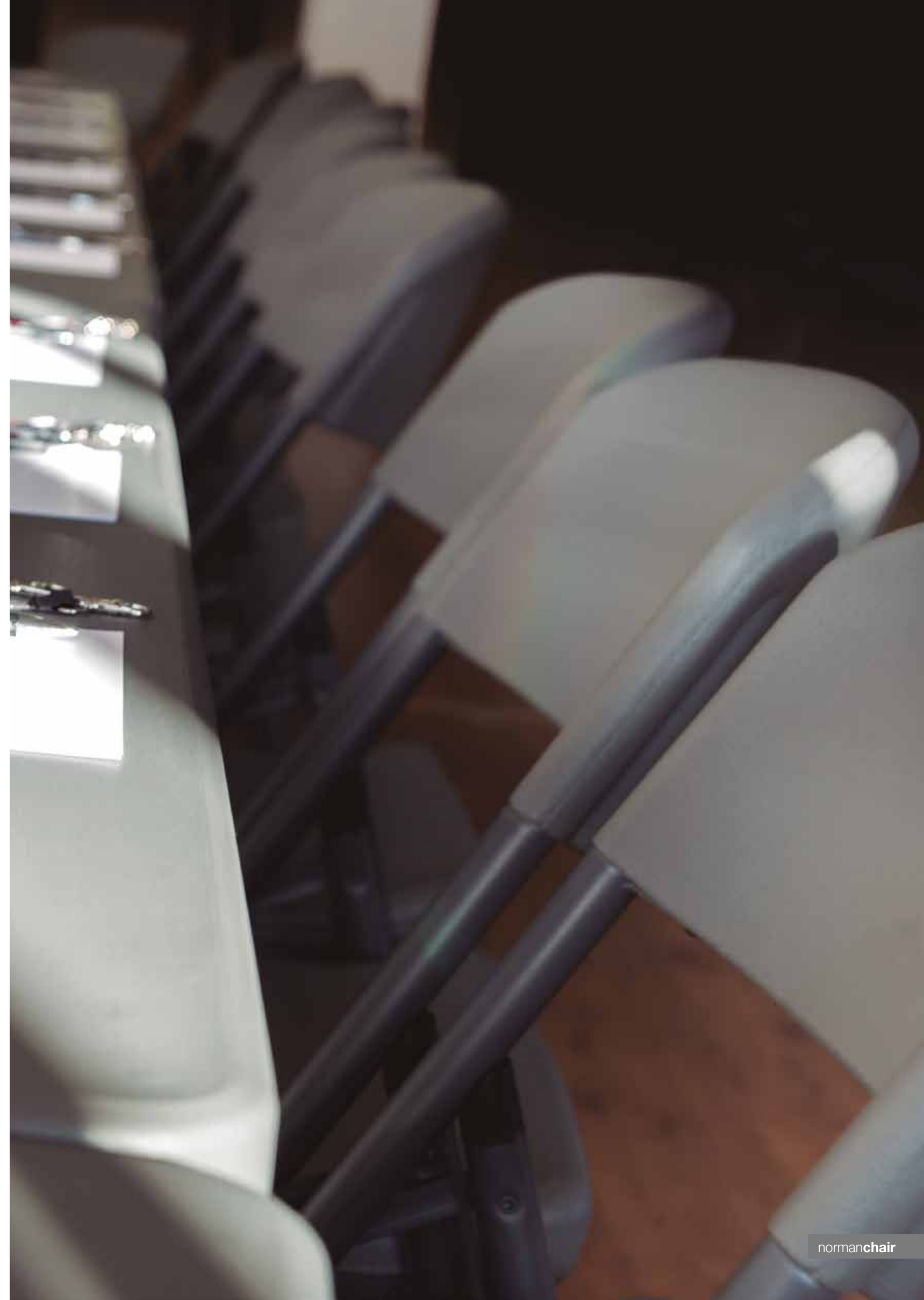


almaarmchair

CHAIR SILLA CHAISE STUHL

SK014F002A
59 x 51.7 x H82.6 cm
23.2" x 20.3" x H32.5"

Pg. 143



Partial table skirt

| Code | Product name | Suitable for the furniture | Use | Shape | Colour | GTIN-13 | GTIN-14 | Pcs. per bag | Bags per carton | G. per bag | lb. per bag | GW per carton (kg) | GW per carton (lb) | Polybag size cm | L bag | W bag | H bag | Polybag size in | L bag | W bag | H bag | Carton size cm | L carton | W carton | H carton | Carton size in | L carton | W carton | H carton |
|-------------|-----------------------------------|----------------------------------|-------------|-----------|------------|---------------|----------------|--------------|-----------------|------------|-------------|--------------------|--------------------|-----------------|-------|-------|-------|-----------------|-------|-------|-------|----------------|----------|----------|----------|----------------|----------|----------|----------|
| SPTTP-00566 | paramount partial 150 table skirt | L152 x H74.3 cm L5' x H29.2" | table skirt | paramount | white | 8436539291961 | 18436539291968 | 1 | 12 | 800 | 1.76 | 10.8 | 23.76 | 87 | 40 | 3 | 34.3 | 15.7 | 1.2 | 80 | 50 | 15 | 31.5 | 19.7 | 5.9 | | | | |
| SPTTP-00567 | paramount partial 150 table skirt | L152 x H74.3 cm L5' x H29.2" | table skirt | paramount | black | 8436539291978 | 18436539291975 | 1 | 12 | 800 | 1.76 | 10.8 | 23.76 | 87 | 40 | 3 | 34.3 | 15.7 | 1.2 | 80 | 50 | 15 | 31.5 | 19.7 | 5.9 | | | | |
| SPTT-00569 | paramount partial 150 table skirt | L152 x H74.3 cm L5' x H29.2" | table skirt | paramount | anthracite | 8436539295884 | 18436539295881 | 1 | 12 | 800 | 1.76 | 10.8 | 23.76 | 87 | 40 | 3 | 34.3 | 15.7 | 1.2 | 80 | 50 | 15 | 31.5 | 19.7 | 5.9 | | | | |
| SPTT-00570 | paramount partial 150 table skirt | L152 x H74.3 cm L5' x H29.2" | table skirt | paramount | blue | 8436539295891 | 18436539295898 | 1 | 12 | 800 | 1.76 | 10.8 | 23.76 | 87 | 40 | 3 | 34.3 | 15.7 | 1.2 | 80 | 50 | 15 | 31.5 | 19.7 | 5.9 | | | | |
| SPTT-00571 | paramount partial 150 table skirt | L152 x H74.3 cm L5' x H29.2" | table skirt | paramount | burgundy | 8436539295907 | 18436539295904 | 1 | 12 | 800 | 1.76 | 10.8 | 23.76 | 87 | 40 | 3 | 34.3 | 15.7 | 1.2 | 80 | 50 | 15 | 31.5 | 19.7 | 5.9 | | | | |
| SPTT-01180 | paramount partial 150 table skirt | L152 x H74.3 cm L5' x H29.2" | table skirt | paramount | sand | 8436539303176 | 18436539303173 | 1 | 12 | 800 | 1.76 | 10.8 | 23.76 | 87 | 40 | 3 | 34.3 | 15.7 | 1.2 | 80 | 50 | 15 | 31.5 | 19.7 | 5.9 | | | | |
| SPTTP-01181 | paramount partial 150 table skirt | L152 x H74.3 cm L5' x H29.2" | table skirt | paramount | ecru | 8436539303183 | 18436539303180 | 1 | 12 | 800 | 1.76 | 10.8 | 23.76 | 87 | 40 | 3 | 34.3 | 15.7 | 1.2 | 80 | 50 | 15 | 31.5 | 19.7 | 5.9 | | | | |
| SPTTP-00572 | paramount partial 180 table skirt | L183 x H74.3 cm L6' x H29.2" | table skirt | paramount | white | 8436539291985 | 18436539291982 | 1 | 10 | 900 | 1.98 | 10.3 | 22.66 | 88 | 45 | 3 | 34.6 | 17.7 | 1.2 | 80 | 50 | 15 | 31.5 | 19.7 | 5.9 | | | | |
| SPTTP-00573 | paramount partial 180 table skirt | L183 x H74.3 cm L6' x H29.2" | table skirt | paramount | black | 8436539291992 | 18436539291999 | 1 | 10 | 900 | 1.98 | 10.3 | 22.66 | 88 | 45 | 3 | 34.6 | 17.7 | 1.2 | 80 | 50 | 15 | 31.5 | 19.7 | 5.9 | | | | |
| SPTT-00575 | paramount partial 180 table skirt | L183 x H74.3 cm L6' x H29.2" | table skirt | paramount | anthracite | 8436539295921 | 18436539295928 | 1 | 10 | 900 | 1.98 | 10.3 | 22.66 | 88 | 45 | 3 | 34.6 | 17.7 | 1.2 | 80 | 50 | 15 | 31.5 | 19.7 | 5.9 | | | | |
| SPTT-00576 | paramount partial 180 table skirt | L183 x H74.3 cm L6' x H29.2" | table skirt | paramount | blue | 8436539295938 | 18436539295935 | 1 | 10 | 900 | 1.98 | 10.3 | 22.66 | 88 | 45 | 3 | 34.6 | 17.7 | 1.2 | 80 | 50 | 15 | 31.5 | 19.7 | 5.9 | | | | |
| SPTT-00577 | paramount partial 180 table skirt | L183 x H74.3 cm L6' x H29.2" | table skirt | paramount | burgundy | 8436539295945 | 18436539295942 | 1 | 10 | 900 | 1.98 | 10.3 | 22.66 | 88 | 45 | 3 | 34.6 | 17.7 | 1.2 | 80 | 50 | 15 | 31.5 | 19.7 | 5.9 | | | | |
| SPTT-01182 | paramount partial 180 table skirt | L183 x H74.3 cm L6' x H29.2" | table skirt | paramount | sand | 8436539303190 | 18436539303197 | 1 | 10 | 900 | 1.98 | 10.3 | 22.66 | 88 | 45 | 3 | 34.6 | 17.7 | 1.2 | 80 | 50 | 15 | 31.5 | 19.7 | 5.9 | | | | |
| SPTTP-01183 | paramount partial 180 table skirt | L183 x H74.3 cm L6' x H29.2" | table skirt | paramount | ecru | 8436539303206 | 18436539303203 | 1 | 10 | 900 | 1.98 | 10.3 | 22.66 | 88 | 45 | 3 | 34.6 | 17.7 | 1.2 | 80 | 50 | 15 | 31.5 | 19.7 | 5.9 | | | | |
| SPTTP-00578 | paramount partial 200 table skirt | L200 x H74.3 cm L6.5' x 29.2" | table skirt | paramount | white | 8436539292005 | 18436539292002 | 1 | 10 | 950 | 2.09 | 10.8 | 23.76 | 87 | 44 | 4 | 34.3 | 17.3 | 1.6 | 80 | 50 | 15 | 31.5 | 19.7 | 5.9 | | | | |
| SPTTP-00579 | paramount partial 200 table skirt | L200 x H74.3 cm L6.5' x 29.2" | table skirt | paramount | black | 8436539292012 | 18436539292019 | 1 | 10 | 950 | 2.09 | 10.8 | 23.76 | 87 | 44 | 4 | 34.3 | 17.3 | 1.6 | 80 | 50 | 15 | 31.5 | 19.7 | 5.9 | | | | |
| SPTT-00581 | paramount partial 200 table skirt | L200 x H74.3 cm L6.5' x 29.2" | table skirt | paramount | anthracite | 8436539295969 | 18436539295966 | 1 | 10 | 950 | 2.09 | 10.8 | 23.76 | 87 | 44 | 4 | 34.3 | 17.3 | 1.6 | 80 | 50 | 15 | 31.5 | 19.7 | 5.9 | | | | |
| SPTT-00582 | paramount partial 200 table skirt | L200 x H74.3 cm L6.5' x 29.2" | table skirt | paramount | blue | 8436539295976 | 18436539295973 | 1 | 10 | 950 | 2.09 | 10.8 | 23.76 | 87 | 44 | 4 | 34.3 | 17.3 | 1.6 | 80 | 50 | 15 | 31.5 | 19.7 | 5.9 | | | | |
| SPTT-00583 | paramount partial 200 table skirt | L200 x H74.3 cm L6.5' x 29.2" | table skirt | paramount | burgundy | 8436539295983 | 18436539295980 | 1 | 10 | 950 | 2.09 | 10.8 | 23.76 | 87 | 44 | 4 | 34.3 | 17.3 | 1.6 | 80 | 50 | 15 | 31.5 | 19.7 | 5.9 | | | | |
| SPTT-01184 | paramount partial 200 table skirt | L200 x H74.3 cm L6.5' x 29.2" | table skirt | paramount | sand | 8436539303213 | 18436539303210 | 1 | 10 | 950 | 2.09 | 10.8 | 23.76 | 87 | 44 | 4 | 34.3 | 17.3 | 1.6 | 80 | 50 | 15 | 31.5 | 19.7 | 5.9 | | | | |
| SPTTP-01185 | paramount partial 200 table skirt | L200 x H74.3 cm L6.5' x 29.2" | table skirt | paramount | ecru | 8436539303220 | 18436539303227 | 1 | 10 | 950 | 2.09 | 10.8 | 23.76 | 87 | 44 | 4 | 34.3 | 17.3 | 1.6 | 80 | 50 | 15 | 31.5 | 19.7 | 5.9 | | | | |
| SPTTP-00584 | paramount partial 240 table skirt | L244 x H74.3 cm L8' x H29.2" | table skirt | paramount | white | 8436539292029 | 18436539292026 | 1 | 8 | 1100 | 2.43 | 10 | 22 | 86 | 40 | 5 | 33.9 | 15.7 | 2.0 | 80 | 50 | 15 | 31.5 | 19.7 | 5.9 | | | | |
| SPTTP-00585 | paramount partial 240 table skirt | L244 x H74.3 cm L8' x H29.2" | table skirt | paramount | black | 8436539292036 | 18436539292033 | 1 | 8 | 1100 | 2.43 | 10 | 22 | 86 | 40 | 5 | 33.9 | 15.7 | 2.0 | 80 | 50 | 15 | 31.5 | 19.7 | 5.9 | | | | |
| SPTT-00587 | paramount partial 240 table skirt | L244 x H74.3 cm L8' x H29.2" | table skirt | paramount | anthracite | 8436539296003 | 18436539296000 | 1 | 8 | 1100 | 2.43 | 10 | 22 | 86 | 40 | 5 | 33.9 | 15.7 | 2.0 | 80 | 50 | 15 | 31.5 | 19.7 | 5.9 | | | | |
| SPTT-00588 | paramount partial 240 table skirt | L244 x H74.3 cm L8' x H29.2" | table skirt | paramount | blue | 8436539296010 | 18436539296017 | 1 | 8 | 1100 | 2.43 | 10 | 22 | 86 | 40 | 5 | 33.9 | 15.7 | 2.0 | 80 | 50 | 15 | 31.5 | 19.7 | 5.9 | | | | |
| SPTT-00589 | paramount partial 240 table skirt | L244 x H74.3 cm L8' x H29.2" | table skirt | paramount | burgundy | 8436539296027 | 18436539296024 | 1 | 8 | 1100 | 2.43 | 10 | 22 | 86 | 40 | 5 | 33.9 | 15.7 | 2.0 | 80 | 50 | 15 | 31.5 | 19.7 | 5.9 | | | | |
| SPTT-01186 | paramount partial 240 table skirt | L244 x H74.3 cm L8' x H29.2" | table skirt | paramount | sand | 8436539303237 | 18436539303234 | 1 | 8 | 1100 | 2.43 | 10 | 22 | 86 | 40 | 5 | 33.9 | 15.7 | 2.0 | 80 | 50 | 15 | 31.5 | 19.7 | 5.9 | | | | |
| SPTTP-01187 | paramount partial 240 table skirt | L244 x H74.3 cm L8' x H29.2" | table skirt | paramount | ecru | 8436539303244 | 18436539303241 | 1 | 8 | 1100 | 2.43 | 10 | 22 | 86 | 40 | 5 | 33.9 | 15.7 | 2.0 | 80 | 50 | 15 | 31.5 | 19.7 | 5.9 | | | | |

| Code | Product name | Suitable for the furniture | Use | Shape | Colour | GTIN-13 | GTIN-14 | Pcs. per bag | Bags per carton | G. per bag | lb. per bag | GW per carton (kg) | GW per carton (lb) | Polybag size cm | L bag | W bag | H bag | Polybag size in | L bag | W bag | H bag | Carton size cm | L carton | W carton | H carton | Carton size in | L carton | W carton | H carton |
|-------------|-----------------------------------|---------------------------------|-------------|-----------|------------|---------------|----------------|--------------|-----------------|------------|-------------|--------------------|--------------------|-----------------|-------|-------|-------|-----------------|-------|-------|-------|----------------|----------|----------|----------|----------------|----------|----------|----------|
| SPTTP-00590 | paramount partial XL table skirt | L76 x H74.3 cm L30" x H29.2" | table skirt | paramount | white | 8436539292043 | 18436539292040 | 1 | 20 | 450 | 0.99 | 10.3 | 22.66 | 85 | 41 | 1 | 33.5 | 16.1 | 0.4 | 80 | 50 | 15 | 31.5 | 19.7 | 5.9 | | | | |
| SPTTP-00591 | paramount partial XL table skirt | L76 x H74.3 cm L30" x H29.2" | table skirt | paramount | black | 8436539292050 | 18436539292057 | 1 | 20 | 450 | 0.99 | 10.3 | 22.66 | 85 | 41 | 1 | 33.5 | 16.1 | 0.4 | 80 | 50 | 15 | 31.5 | 19.7 | 5.9 | | | | |
| SPTT-00593 | paramount partial XL table skirt | L76 x H74.3 cm L30" x H29.2" | table skirt | paramount | anthracite | 8436539296041 | 18436539296048 | 1 | 20 | 450 | 0.99 | 10.3 | 22.66 | 85 | 41 | 1 | 33.5 | 16.1 | 0.4 | 80 | 50 | 15 | 31.5 | 19.7 | 5.9 | | | | |
| SPTT-00594 | paramount partial XL table skirt | L76 x H74.3 cm L30" x H29.2" | table skirt | paramount | blue | 8436539296058 | 18436539296055 | 1 | 20 | 450 | 0.99 | 10.3 | 22.66 | 85 | 41 | 1 | 33.5 | 16.1 | 0.4 | 80 | 50 | 15 | 31.5 | 19.7 | 5.9 | | | | |
| SPTT-00595 | paramount partial XL table skirt | L76 x H74.3 cm L30" x H29.2" | table skirt | paramount | burgundy | 8436539296065 | 18436539296062 | 1 | 20 | 450 | 0.99 | 10.3 | 22.66 | 85 | 41 | 1 | 33.5 | 16.1 | 0.4 | 80 | 50 | 15 | 31.5 | 19.7 | 5.9 | | | | |
| SPTT-01188 | paramount partial XL table skirt | L76 x H74.3 cm L30" x H29.2" | table skirt | paramount | sand | 8436539303251 | 18436539303258 | 1 | 20 | 450 | 0.99 | 10.3 | 22.66 | 85 | 41 | 1 | 33.5 | 16.1 | 0.4 | 80 | 50 | 15 | 31.5 | 19.7 | 5.9 | | | | |
| SPTTP-01189 | paramount partial XL table skirt | L76 x H74.3 cm L30" x H29.2" | table skirt | paramount | ecru | 8436539303268 | 18436539303265 | 1 | 20 | 450 | 0.99 | 10.3 | 22.66 | 85 | 41 | 1 | 33.5 | 16.1 | 0.4 | 80 | 50 | 15 | 31.5 | 19.7 | 5.9 | | | | |
| SPTTP-00614 | paramount partial XXL table skirt | L91 x H74.3 cm L36" x H29.2" | table skirt | paramount | white | 8436539292128 | 18436539292125 | 1 | 10 | 550 | 1.21 | 6.5 | 14.3 | 87 | 45 | 1 | 34.3 | 17.7 | 0.4 | 80 | 50 | 15 | 31.5 | 19.7 | 5.9 | | | | |
| SPTTP-00615 | paramount partial XXL table skirt | L91 x H74.3 cm L36" x H29.2" | table skirt | paramount | black | 8436539292135 | 18436539292132 | 1 | 10 | 550 | 1.21 | 6.5 | 14.3 | 87 | 45 | 1 | 34.3 | 17.7 | 0.4 | 80 | 50 | 15 | 31.5 | 19.7 | 5.9 | | | | |
| SPTT-00617 | paramount partial XXL table skirt | L91 x H74.3 cm L36" x H29.2" | table skirt | paramount | anthracite | 8436539296201 | 18436539296208 | 1 | 10 | 550 | 1.21 | 6.5 | 14.3 | 87 | 45 | 1 | 34.3 | 17.7 | 0.4 | 80 | 50 | 15 | 31.5 | 19.7 | 5.9 | | | | |
| SPTT-00618 | paramount partial XXL table skirt | L91 x H74.3 cm L36" x H29.2" | table skirt | paramount | blue | 8436539296218 | 18436539296215 | 1 | 10 | 550 | 1.21 | 6.5 | 14.3 | 87 | 45 | 1 | 34.3 | 17.7 | 0.4 | 80 | 50 | 15 | 31.5 | 19.7 | 5.9 | | | | |
| SPTT-00619 | paramount partial XXL table skirt | L91 x H74.3 cm L36" x H29.2" | table skirt | paramount | burgundy | 8436539296225 | 18436539296222 | 1 | 10 | 550 | 1.21 | 6.5 | 14.3 | 87 | 45 | 1 | 34.3 | 17.7 | 0.4 | 80 | 50 | 15 | 31.5 | 19.7 | 5.9 | | | | |
| SPTT-01190 | paramount partial XXL table skirt | L91 x H74.3 cm L36" x H29.2" | table skirt | paramount | sand | 8436539303275 | 18436539303272 | 1 | 10 | 550 | 1.21 | 6.5 | 14.3 | 87 | 45 | 1 | 34.3 | 17.7 | 0.4 | 80 | 50 | 15 | 31.5 | 19.7 | 5.9 | | | | |
| SPTTP-01191 | paramount partial XXL table skirt | L91 x H74.3 cm L36" x H29.2" | table skirt | paramount | ecru | 8436539303282 | 18436539303289 | 1 | 10 | 550 | 1.21 | 6.5 | 14.3 | 87 | 45 | 1 | 34.3 | 17.7 | 0.4 | 80 | 50 | 15 | 31.5 | 19.7 | 5.9 | | | | |



| | | | | | | | | | | | | | | | | | | | | | | | | | | |
|-------------|--------------|--------|-----------------------------|--------|--------|-------|---------------|----------------|----|----|-----|------|----|------|----|----|---|------|-----|-----|----|----|----|------|------|------|
| SPTTP-00638 | table napkin | napkin | 50 x 50 cm 19.7" x 19.7" | napkin | cotton | white | 8436539292203 | 18436539292200 | 10 | 25 | 690 | 1.52 | 18 | 39.6 | 34 | 23 | 3 | 13.4 | 9.1 | 1.2 | 50 | 40 | 30 | 19.7 | 15.7 | 11.8 |
|-------------|--------------|--------|-----------------------------|--------|--------|-------|---------------|----------------|----|----|-----|------|----|------|----|----|---|------|-----|-----|----|----|----|------|------|------|





by
maxchief

Zhuhai Shichang Metals, LTD
No.2 Chuangye Middle Road
Shuanglinpian Zone
Liangang Industrial Area
Zhuhai City
Guangdong Province 519045
CHINA

Maxchief Europe S.L.
Roger de Flor, 95
08013 Barcelona SPAIN
Tel. +34 93 453 66 00
Fax +34 93 451 88 94
info@maxchief.eu
www.maxchief.eu
www.zown.com



@zown.maxchief



@zowncontract



linkedin.com/company/maxchiefeurope



Zown Contract



instagram.com/zowncontract

The tester reloaded



Check out the video!



This demonstration was conducted by professionals in a controlled environment for advertising purposes only. ZOWN® tables are not manufactured or intended for the use shown in this advertisement. Only use ZOWN® products in accordance with the recommendations and warnings on the products' labels and the instructions for use. Attempting to recreate this demonstration could result in property damage, serious injury or death. ZOWN® will not be liable for any loss, damage or injury resulting from improper use of its products or failure to follow product instructions, including use consistent with the advertisement. The maximum recommended weight for the ZOWN XXL180 is 408 kg/900 lbs evenly distributed for twenty-four hours.

Esta demostración ha sido llevada a cabo por profesionales en un ambiente controlado únicamente con fines publicitarios. Las mesas ZOWN® no están fabricadas ni pensadas para el uso mostrado en la publicidad. Utilice los productos ZOWN® únicamente de acuerdo con las recomendaciones y advertencias de las etiquetas de los productos y siguiendo las instrucciones de uso. Intentar recrear esta demostración podría provocar un daño en el producto, una lesión grave o la muerte. ZOWN® no será responsable de ninguna pérdida, daño o lesión que resulte de un uso indebido de sus productos o por no seguir las instrucciones del producto, incluyendo el uso mostrado en la publicidad. El peso máximo recomendado para el modelo ZOWN XXL180 es de 408 KG/900 lbs, distribuido uniformemente, durante veinticuatro horas.

Ce test a été effectué par des professionnels dans un environnement contrôlé uniquement à des fins publicitaires. Les tables ZOWN® ne sont pas conçues ou prévues pour l'usage qui en est fait dans cette annonce publicitaire. Lorsque vous utilisez des produits ZOWN®, veuillez vous conformer aux recommandations et avertissements figurant sur les étiquettes des produits et à leurs instructions d'utilisation. Toute reproduction de ce test peut provoquer des dommages matériels, des blessures graves ou la mort. La société ZOWN® ne saurait être tenue responsable de toute perte, tout dommage ou toute blessure de quelque nature que ce soit résultant d'une utilisation inappropriée de ses produits ou du non-respect de leurs instructions, y compris une utilisation conforme à l'usage prévu. Le poids maximal recommandé, uniformément réparti, que la table ZOWN XXL180 peut supporter pendant 24 heures est de 408 kg.

Diese Demonstration wurde von Fachleuten in einer kontrollierten Umgebung und ausschließlich zu Werbezwecken durchgeführt. ZOWN®-Tische sind nicht für die in dieser Werbung gezeigte Verwendung hergestellt oder bestimmt. Verwenden Sie ZOWN®-Produkte nur in Übereinstimmung mit den Empfehlungen und Warnhinweisen auf den Etiketten der Produkte und den Gebrauchsanweisungen. Der Versuch, diese Demonstration nachzustellen, kann zu Sachschäden, schweren Verletzungen oder zum Tod führen. ZOWN® übernimmt keine Haftung für Verluste, Schäden oder Verletzungen, die sich aus dem unsachgemäßen Gebrauch seiner Produkte oder der Nichtbeachtung der Gebrauchsanweisungen ergeben, einschließlich der Verwendung gemäß der Werbung. Das empfohlene Höchstgewicht für den ZOWN XXL180 beträgt 408 kg/900 lbs, gleichmäßig verteilt und maximal 24 Stunden lang.